

气象学与气候学

第四章 大气运动与大气环流



授课老师：杨静 教授

13426150125

yangjing@bnu.edu.cn

京师科技大厦B901

第四章 大气运动和大气环流

4.3 大气环流

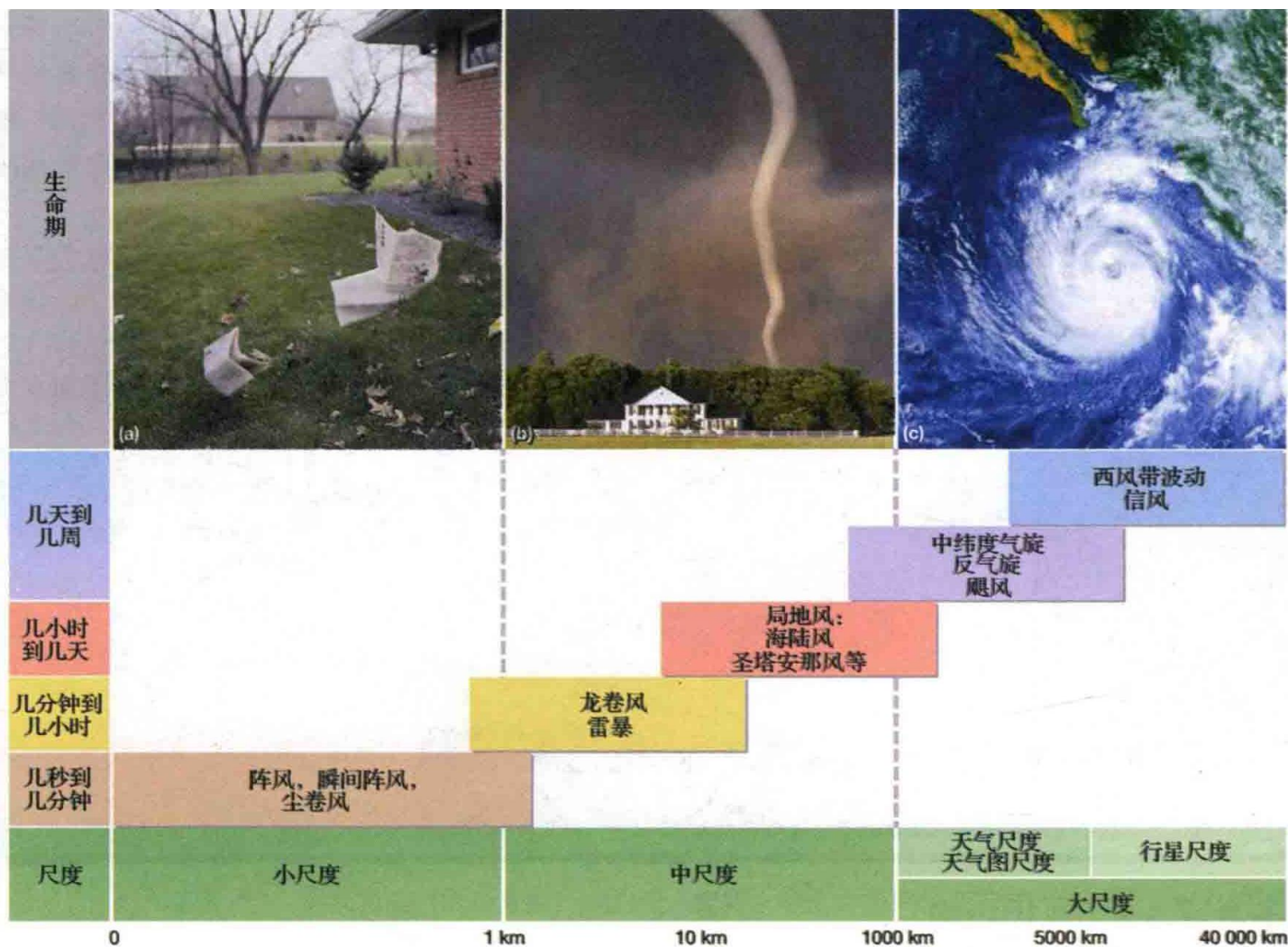

第四章 大气运动和大气环流

4.3 大气环流

- 全球
- 区域与局地

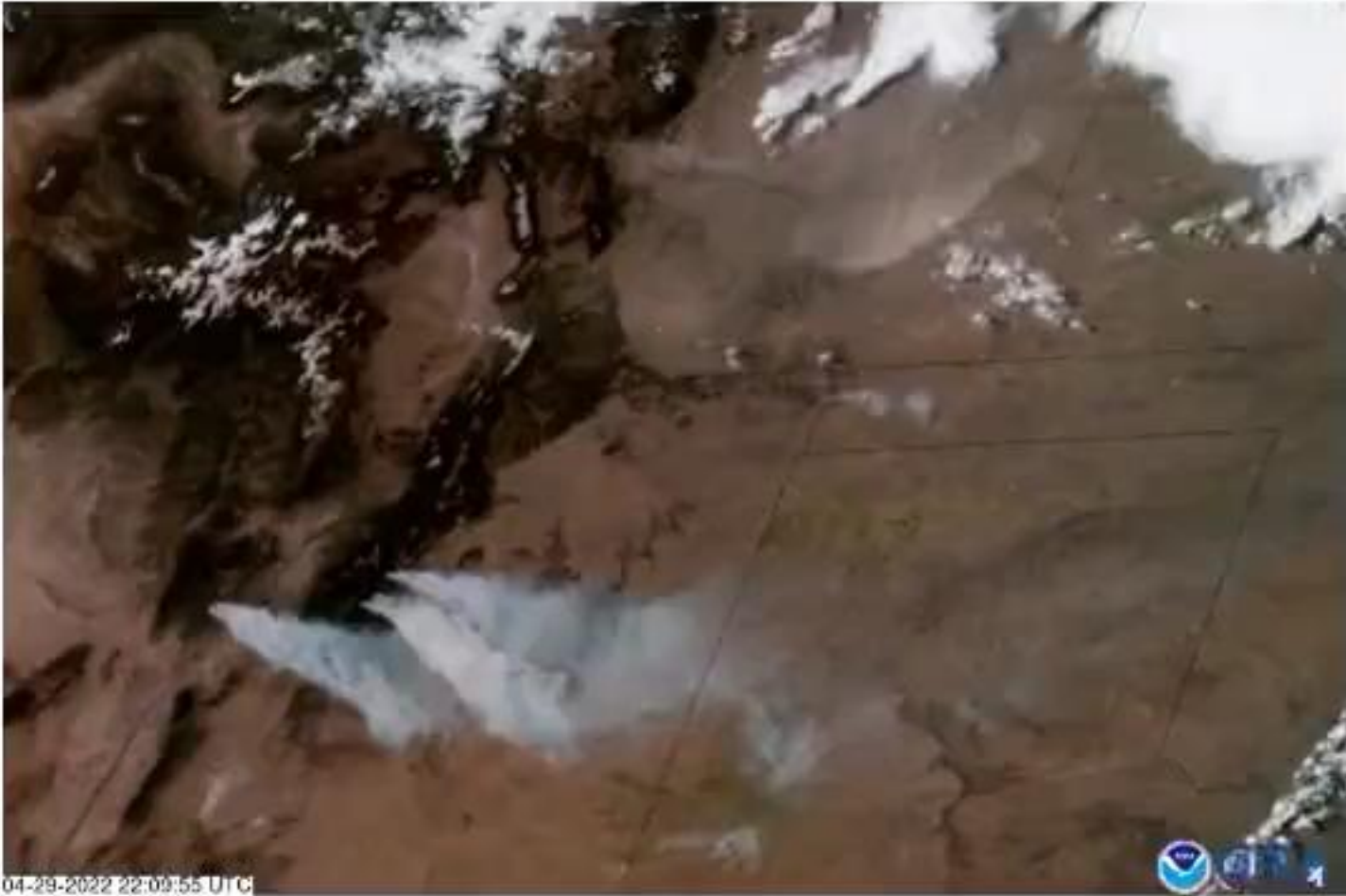

NOAA

Smoke and a Sandstorm, Seen From Space

A time-lapse image of smoke from wildfires in New Mexico and dust from a storm in Colorado illustrates the scope of Western catastrophe.

核辐射物质的泄漏路径 受到 大气环流 的影响

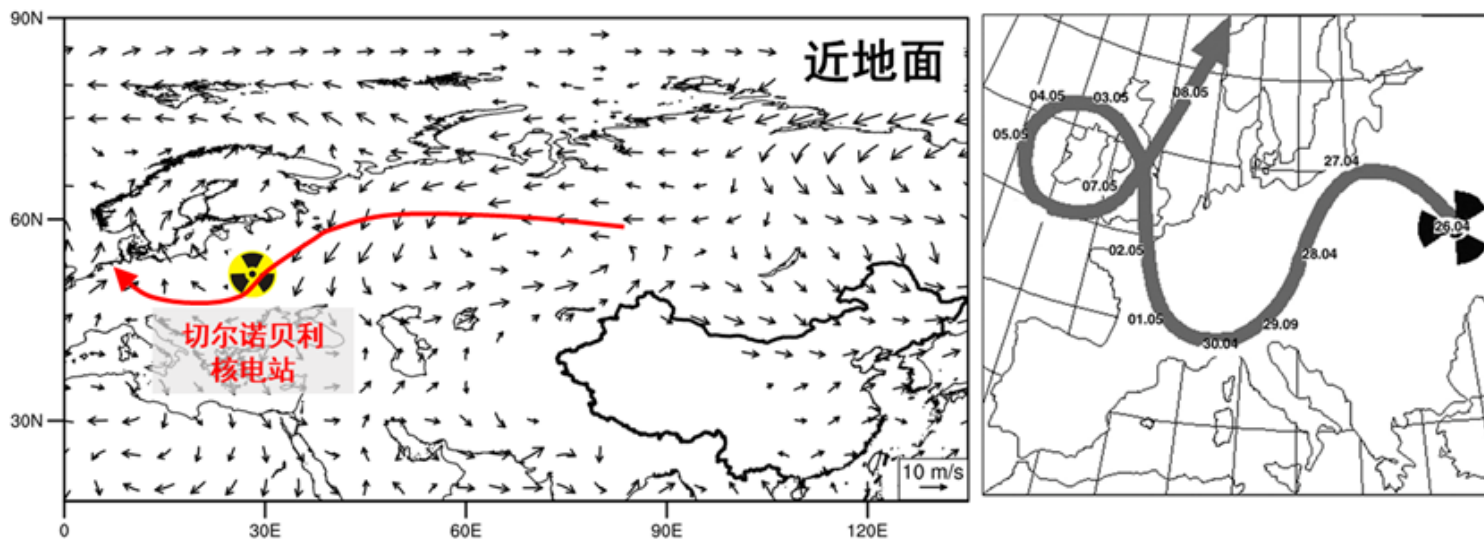

核辐射物质的泄漏路径 受到 大气环流 的影响

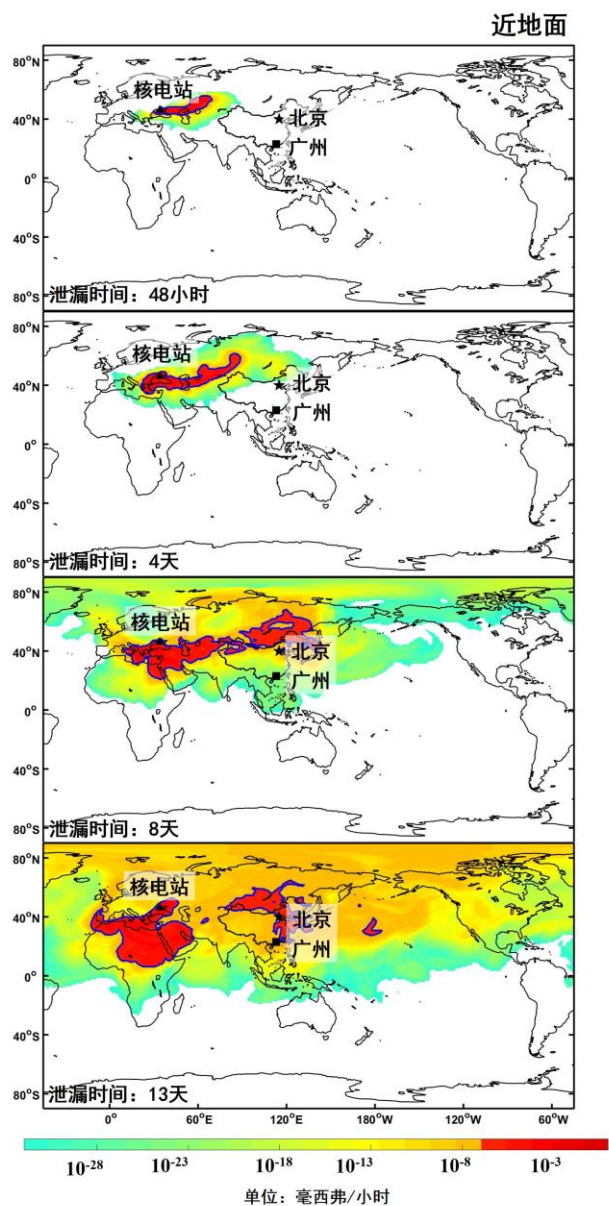

扎波罗热

第四章 大气运动和大气环流

4.3 大气环流：全球

■ 三圈环流



第四章 大气运动和大气环流

4.3 大气环流：全球

■ 三圈环流

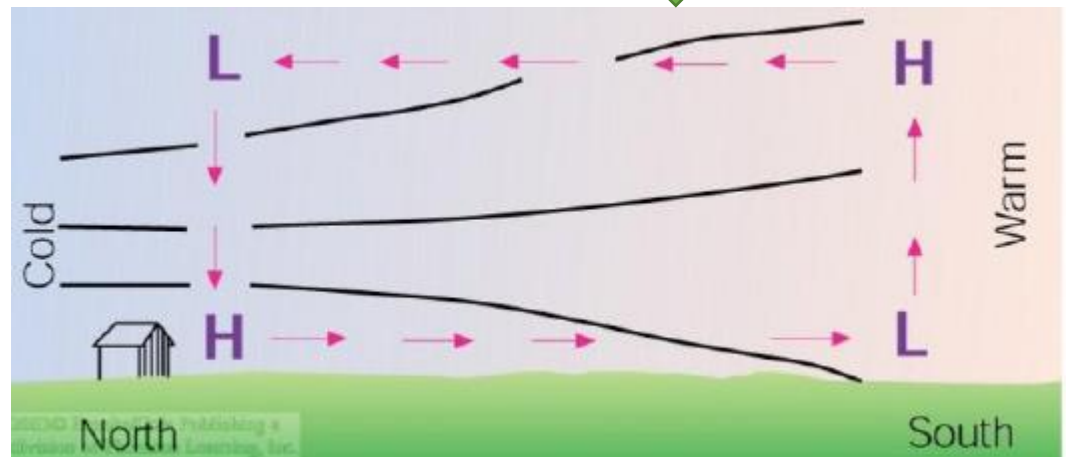
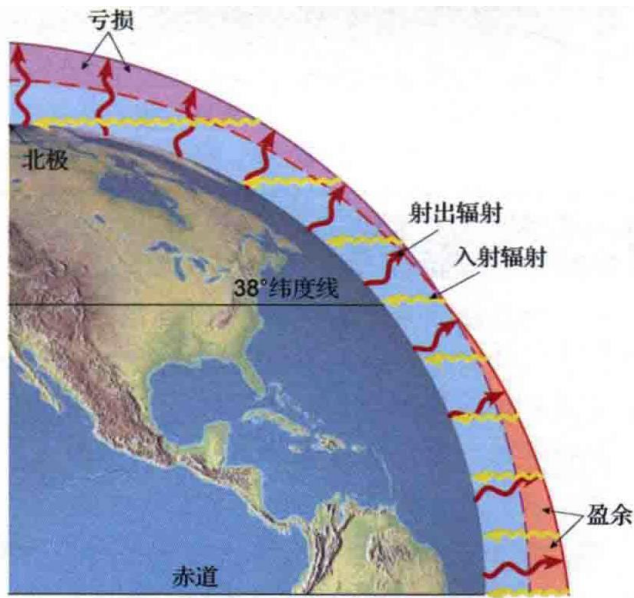

第四章 大气运动和大气环流

4.3 大气环流：全球

■ 三圈环流

单圈环流

- 地球无旋转
- 地表均匀

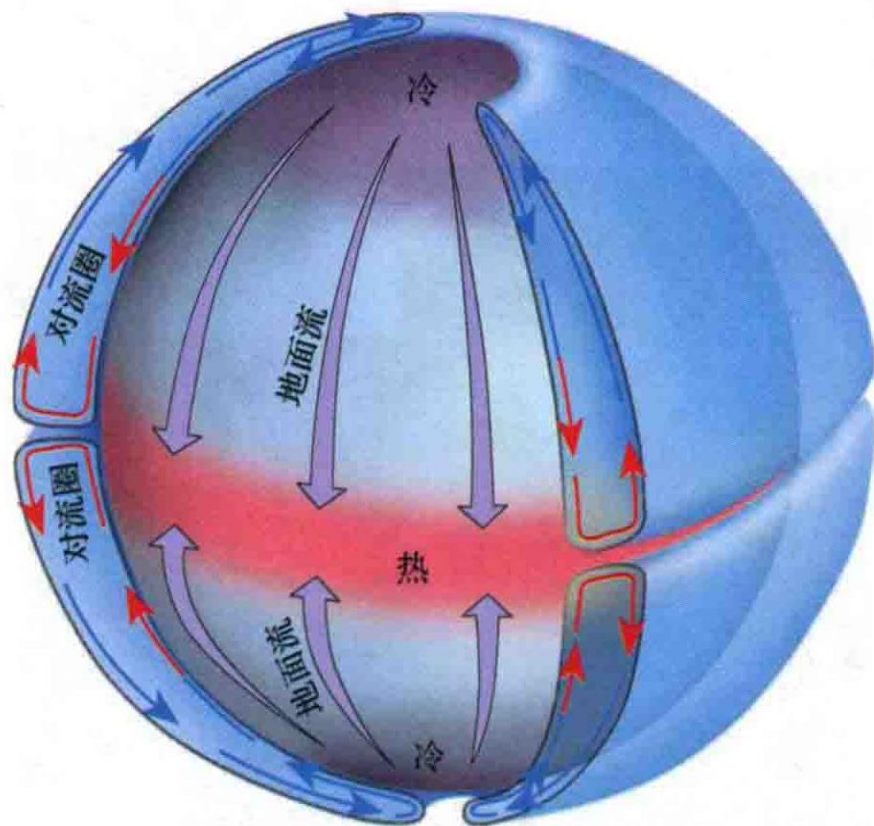

热带赤道辐合带

intertropical convergence zone

(ITCZ)

ITCZ

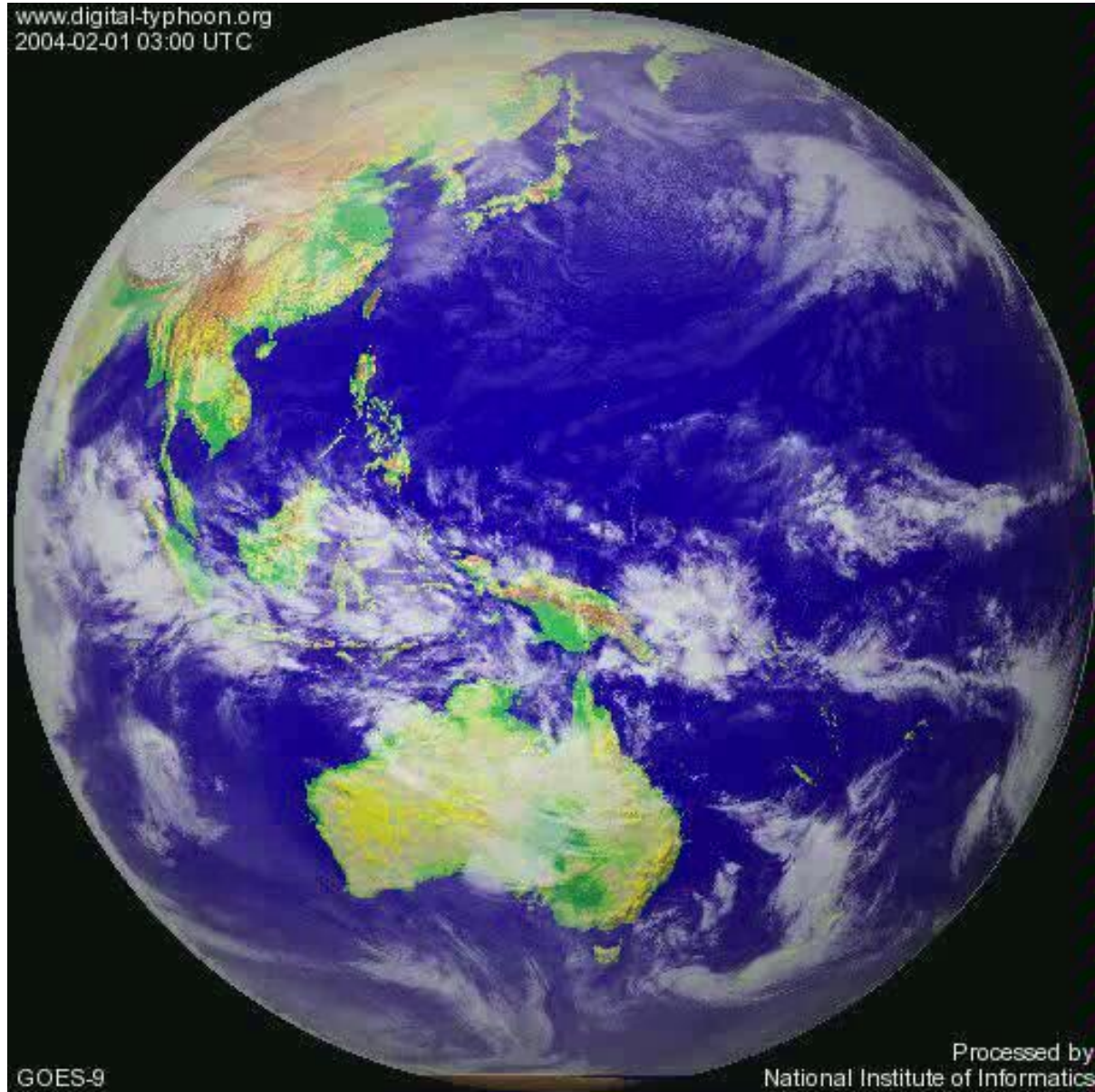

第四章 大气运动和大气环流

4.3 大气环流：全球

旋转地球的三圈环流

■ 三圈环流

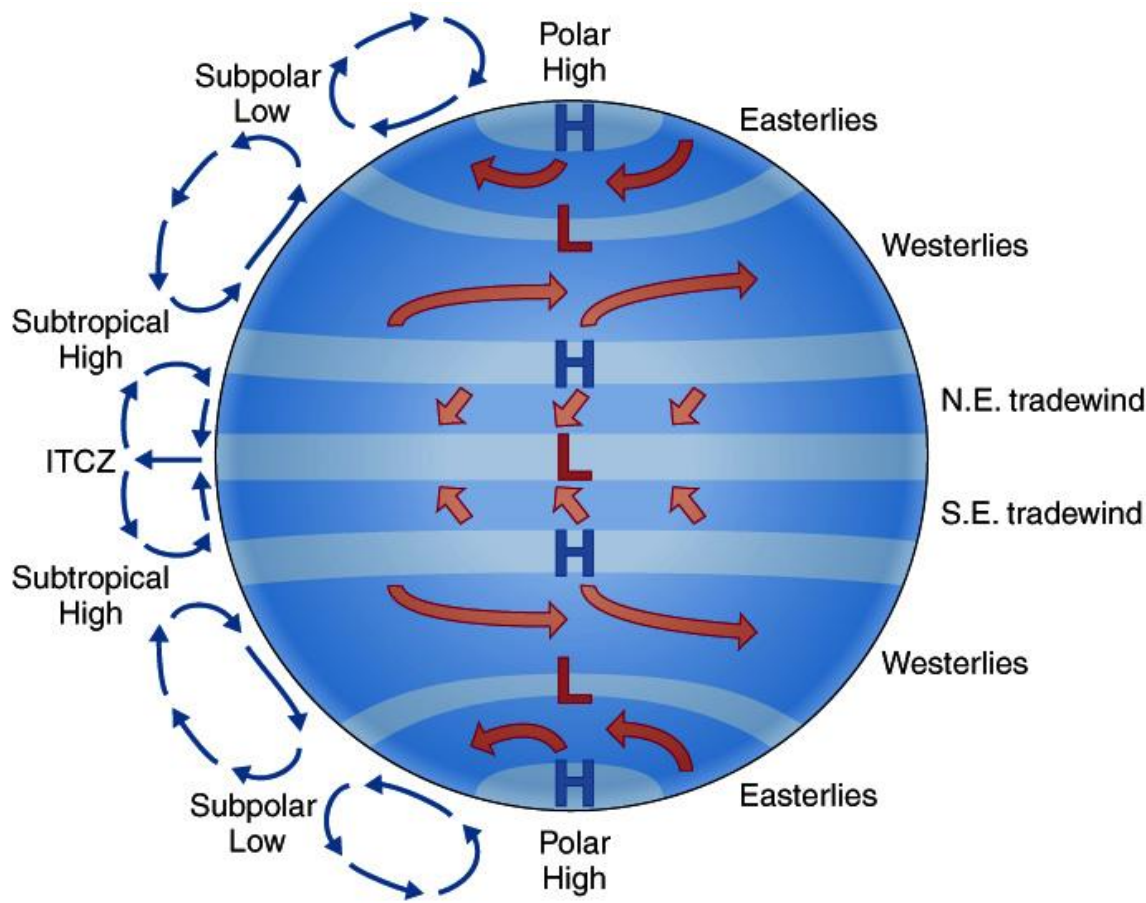

(b)

第四章 大气运动和大气环流

4.3 大气环流：全球

■ 三圈环流

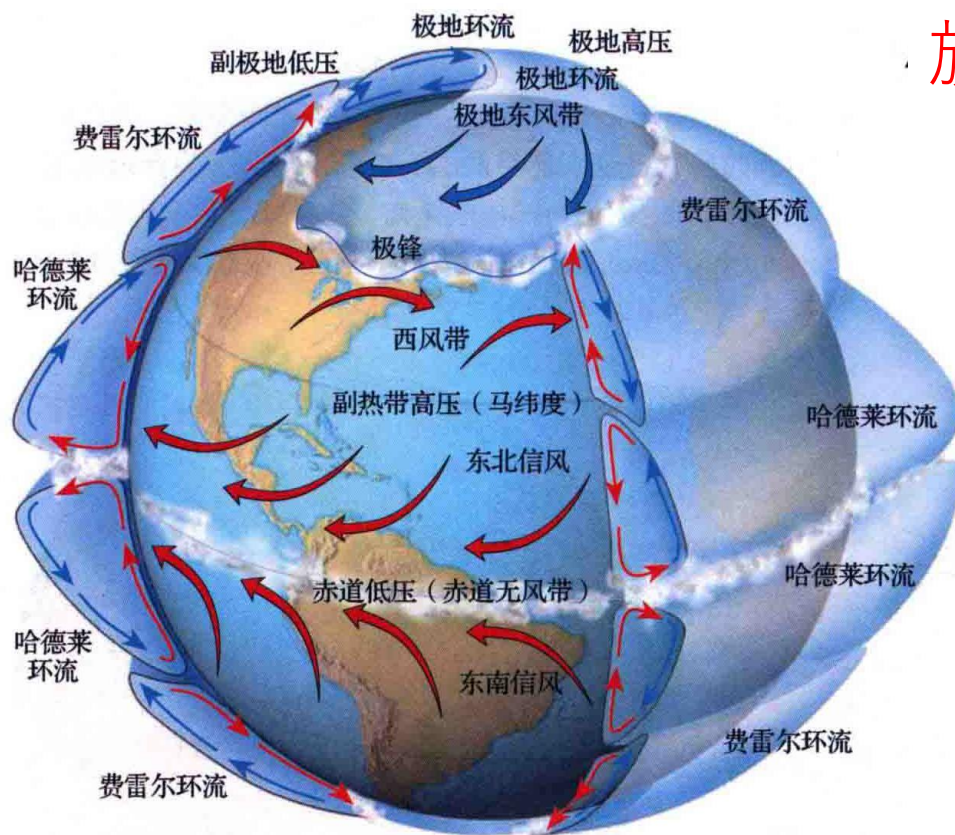

旋转地球的三圈环流

第四章 大气运动和大气环流

4.3 大气环流：全球

■ 三圈环流

理想地面风场

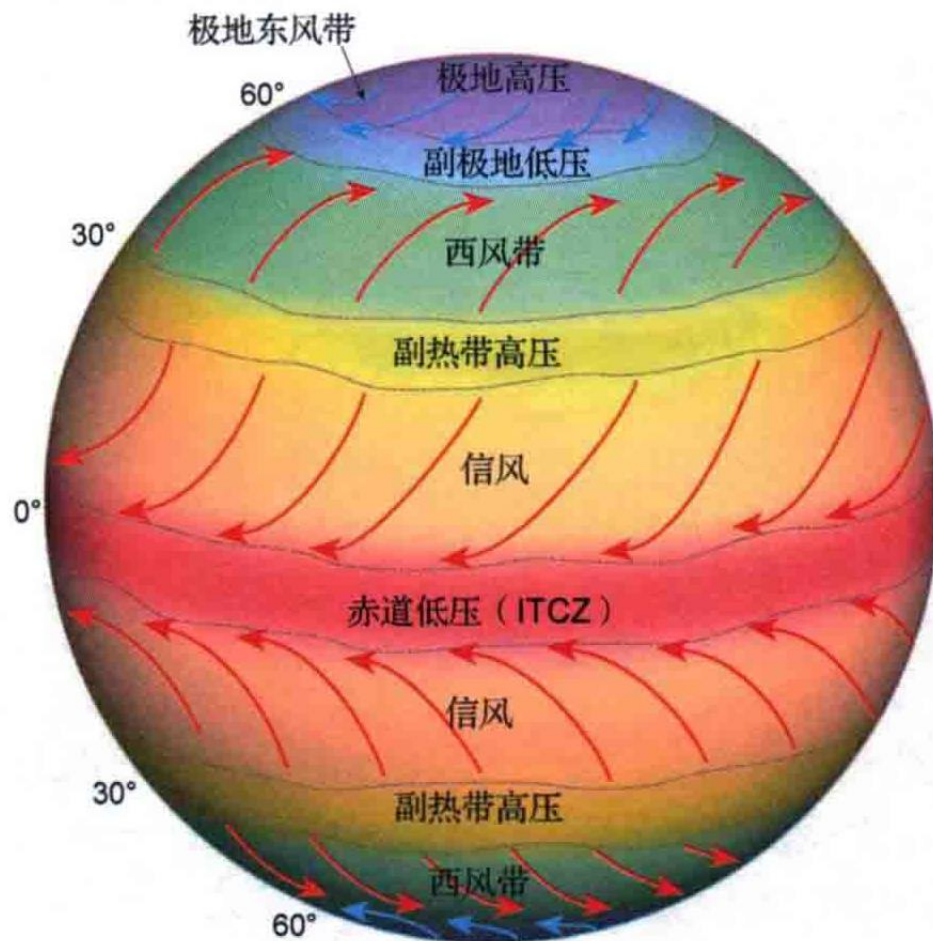

第四章 大气运动和大气环流

4.3 大气环流：全球

■ 三圈环流

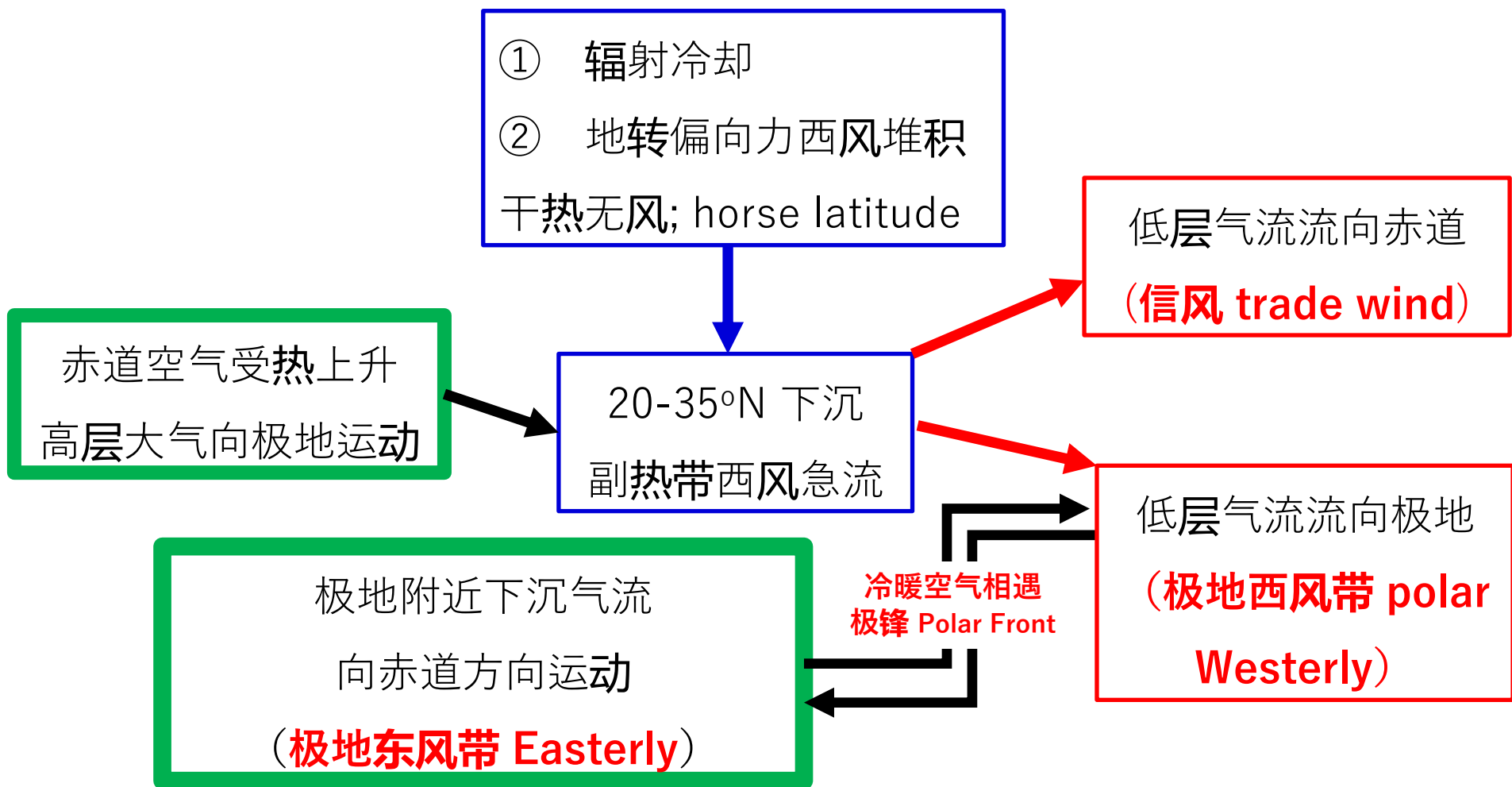

以北半球为例，在对流层高层大气从赤道向两极运动过程中，受到地转偏向力的作用，气流会不断右偏，大约在北纬30°附近偏转为西风；如此，源源不断从南方吹来的高空气流在北纬30°附近堆积，使下方对流层中低层气压增高，堆积的空气在北纬30°下沉增温，形成深厚暖性的**副热带高压带**。一方面，副热带高压带与赤道低压带之间形成气压差，对流层低层产生驶向赤道的风。低层空气向赤道运动过程中，受到地转偏向力作用不断向右偏转，在对流层低层形成稳定的**东北信风**。北半球的东北信风和南半球的东南信风在赤道汇合上升，形成**赤道辐合带（赤道低压带）**。在经圈方向上，低纬度的这一支闭合大气环流称为**低纬环流**，也称为**哈德莱环流**。哈德莱环流是由于南北受热不均而产生的直接热力环流圈。另一方面，由于堆积的空气在北纬30°下沉形成副热带高压带，一支近地面的气流会向极区运动，在地转偏向力作用下不断右偏，形成宽广的**中纬度西风带**。北上的暖空气与从极地南下的冷空气在北纬60°附近相遇。南下的冷空气在地转偏向力作用下形成**极地东风带**。相对暖性的偏西风气流与相对冷性的偏东风气流相遇后，暖空气沿着冷空气向极区爬升，形成**极锋区**，在极锋区的对流层顶附近，在热成风作用下形成**极锋急流**，地面附近形成**副极地低压带**。暖空气爬升到高空，一部分向极地移动，并在极地冷却下沉，形成**高纬环流**；另一支气流向赤道方向运动，并在北纬30度附近下沉，形成**中纬环流**，也被称为“**费雷尔环流**”。由于气柱冷却和下沉作用，极地近地面附近形成**极地高压带**。这样，哈德莱环流、中纬环流和高纬环流合并称为三圈环流。其在近地面附近形成信风带、西风带和极地东风带以及赤道低压带、副热带高压带、副极地低压带和极地高压带并称为“**三风四带**”

第四章 大气运动和大气环流

4.3 大气环流：全球

■ 三圈环流

理想风场（剖面）

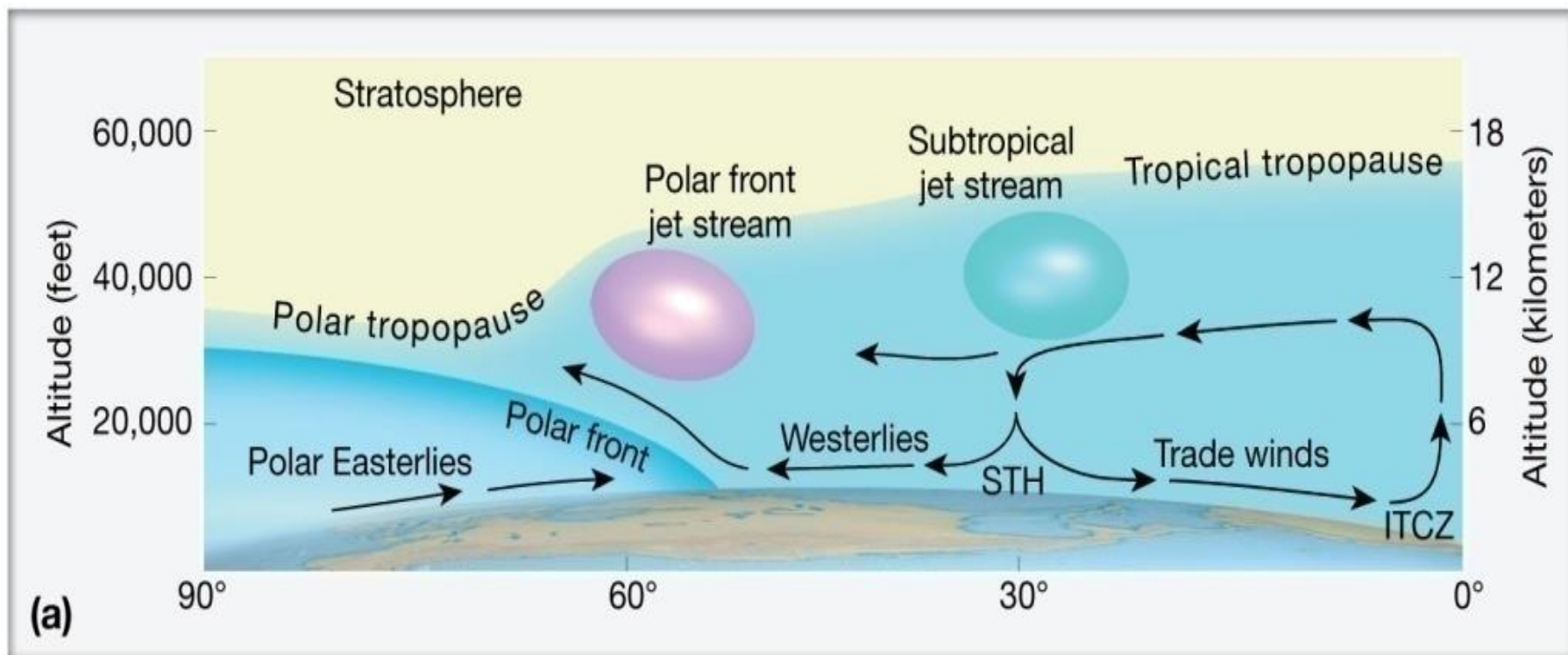

第四章 大气运动和大气环流

4.3 大气环流：全球

■ 三圈环流

理想风场（剖面）

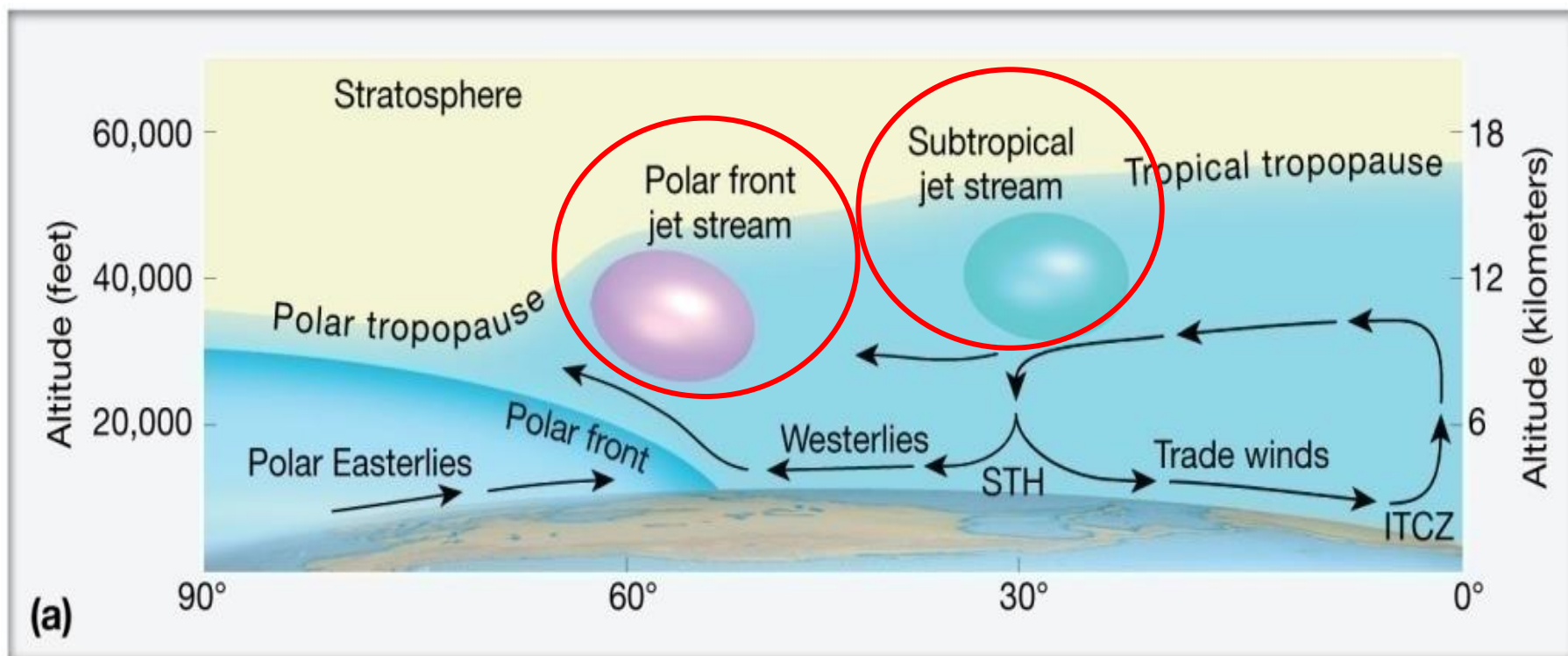

4.3 大气环流：全球

■ 三圈环流 急流：风速30m/s以上的狭窄强风带

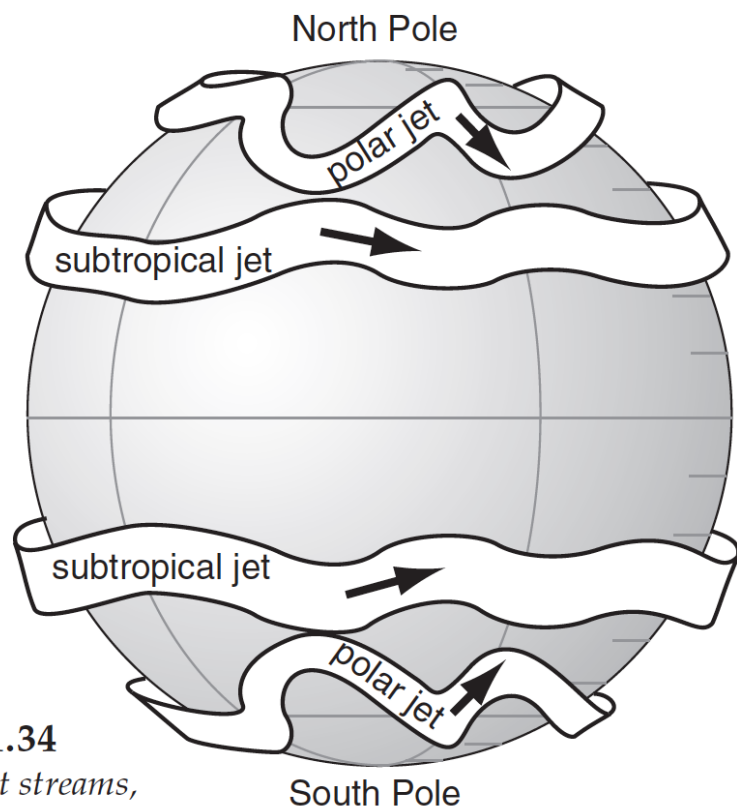

Figure 11.34
Sketch of jet streams,
representing a snapshot.

1. 急流中心强度最大处为**急流轴**
2. 急流中心风速 50-80m/s, 最大处可达100-150m/s
3. 急流速度冬季大可以达200m/s
4. 急流南北有很大的风切边
5. **急流入口和出口容易产生不稳定扰动**, 常对应锋区, 产生重要天气系统

第四章 大气运动和大气环流

4.3 大气环流：全球

■ 三圈环流 急流：风速 30m/s 以上的狭窄强风带

思考1:

高空急流速度与高铁速度（200-400 公里/小时）相比，谁快？



第四章 大气运动和大气环流

4.3 大气环流：全球

■ **三圈环流** 急流：风速30m/s以上的狭窄强风带

思考2：

急流出口的南侧为什么容易形成反气旋异常？

第四章 大气运动和大气环流

4.3 大气环流：全球

三圈环流 副热带急流subtropical jet stream / 极锋急流polar jet stream

冬季：

1. 副热带急流：

- 30°N附近，宽1000km
- 稳定，南北蜿蜒小，
- 急流轴在12km
- 季节平均风速 45-80m/s

2. 极锋急流：

- 60°N附近，宽经向500km
- 不稳定多变，南北蜿蜒大
- 急流轴在9km
- 季节平均风速25-100m/s

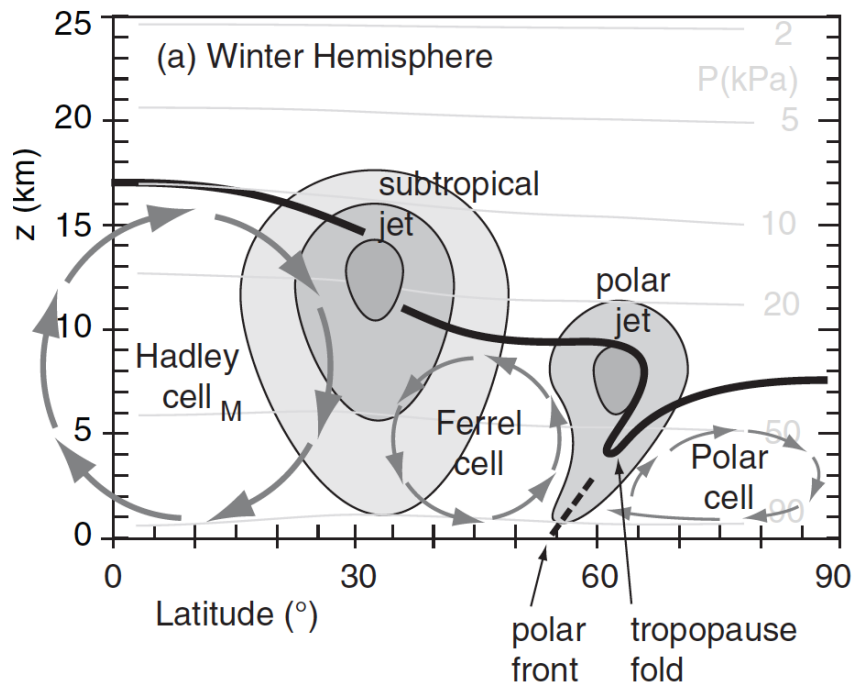

第四章 大气运动和大气环流

4.3 大气环流：全球

■ 三圈环流 副热带急流/极锋急流

思考3:

夏季与冬季比，特点如何？为什么？

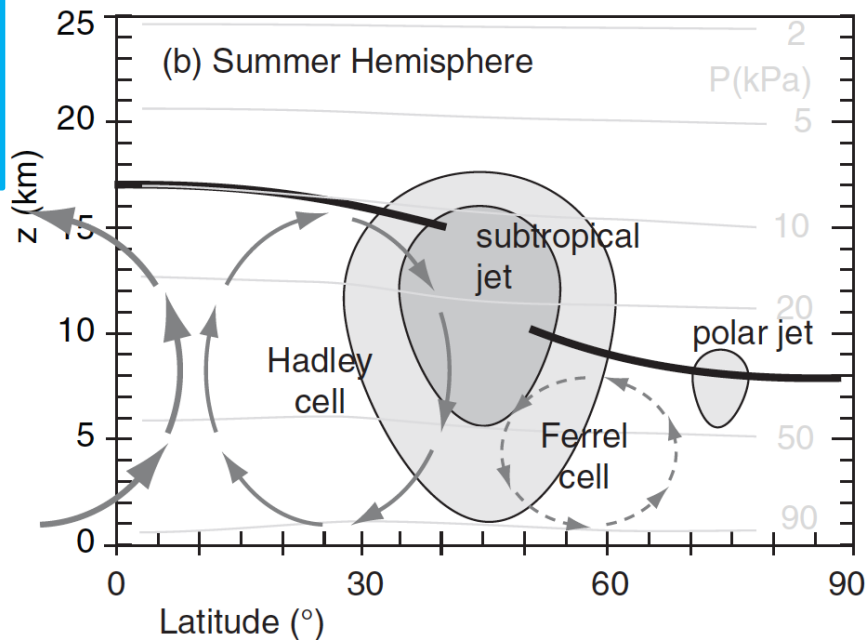

第四章 大气运动和大气环流

4.3 大气环流：全球

■ 三圈环流 副热带急流/极锋急流

思考4:

夏季与冬季比，特点如何？为什么？

- ✓ 减弱，风速减半；
- ✓ 温度梯度减少（暖北极）

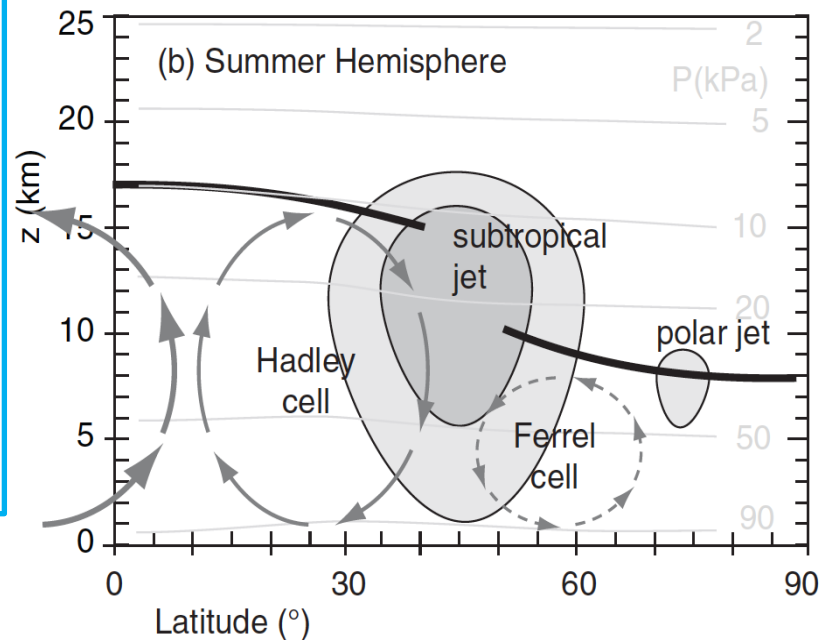

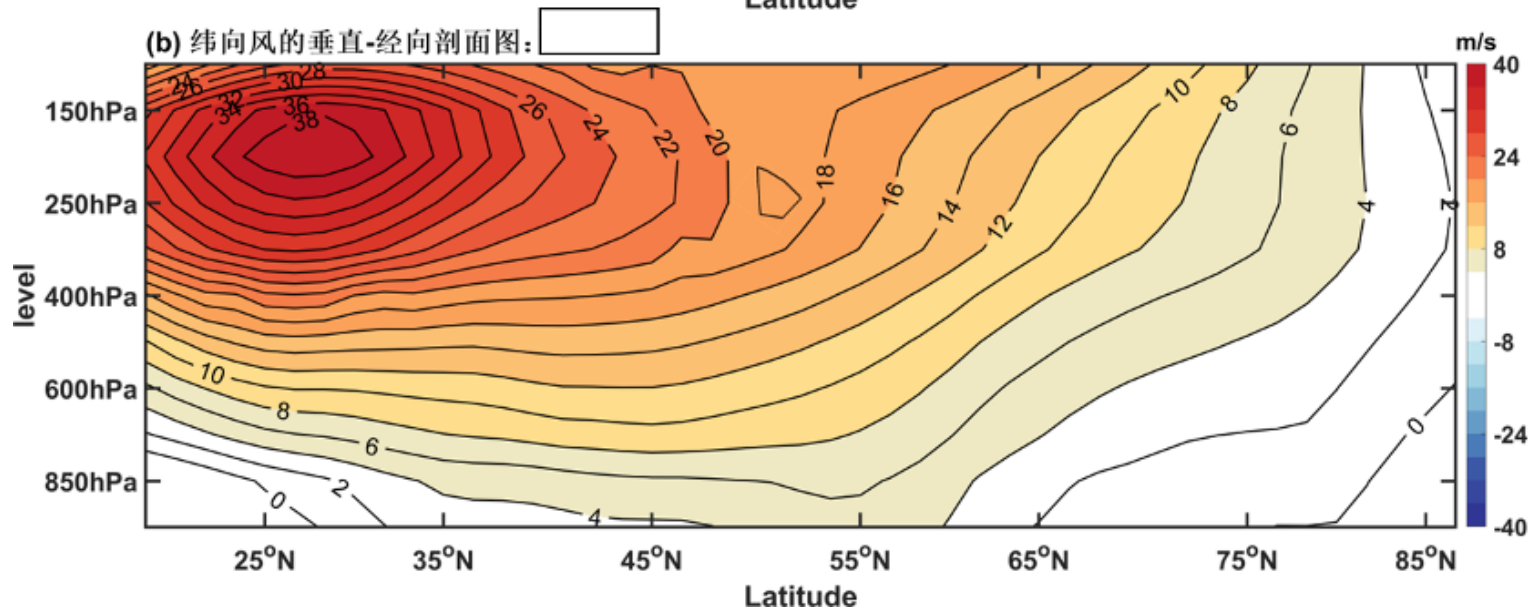
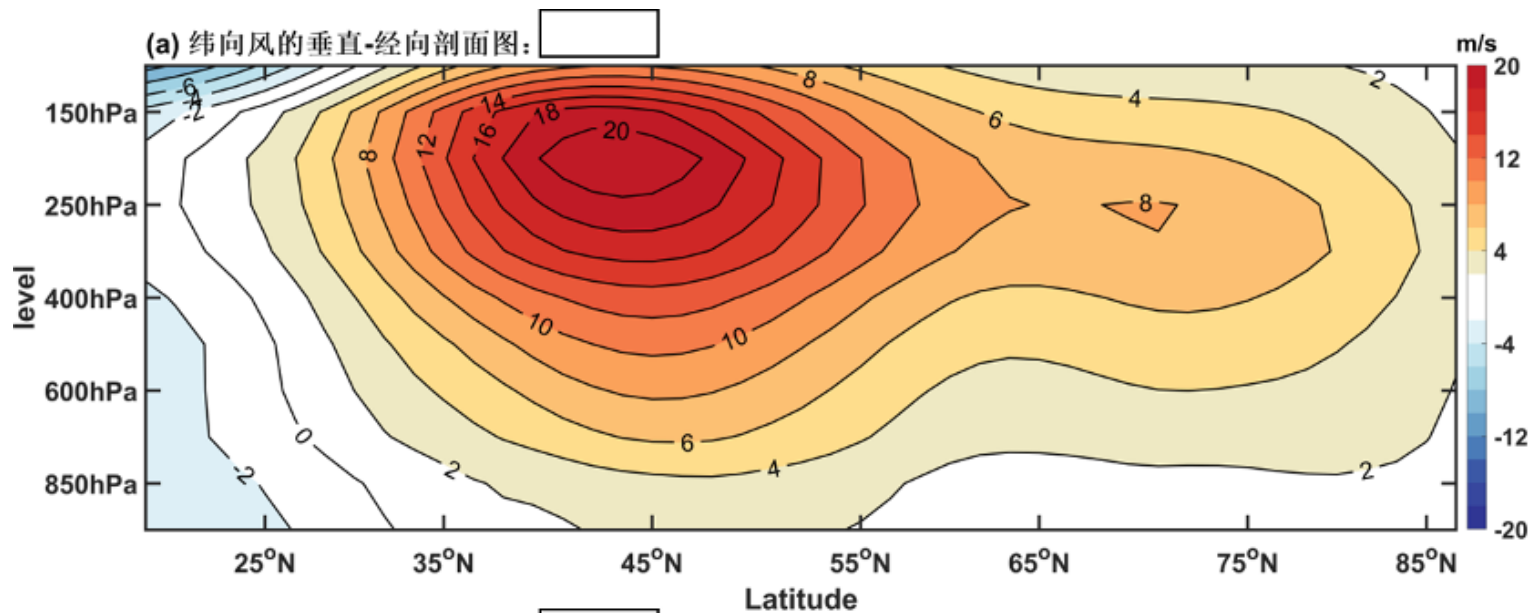

4.3 大气环流：全球

■ 三圈环流 西风急流

思考4：

- ✓ 急流如何形成？
- ✓ 如果地球旋转加快，副热带急流位置可能向哪个方向移动
- ✓ 全球变暖情况下，哈德莱环流经向变宽还是变窄？

Why?

第四章 大气运动和大气环流

4.3 大气环流：全球

■ 三圈环流：西风急流强度与极端冷暖密切相关

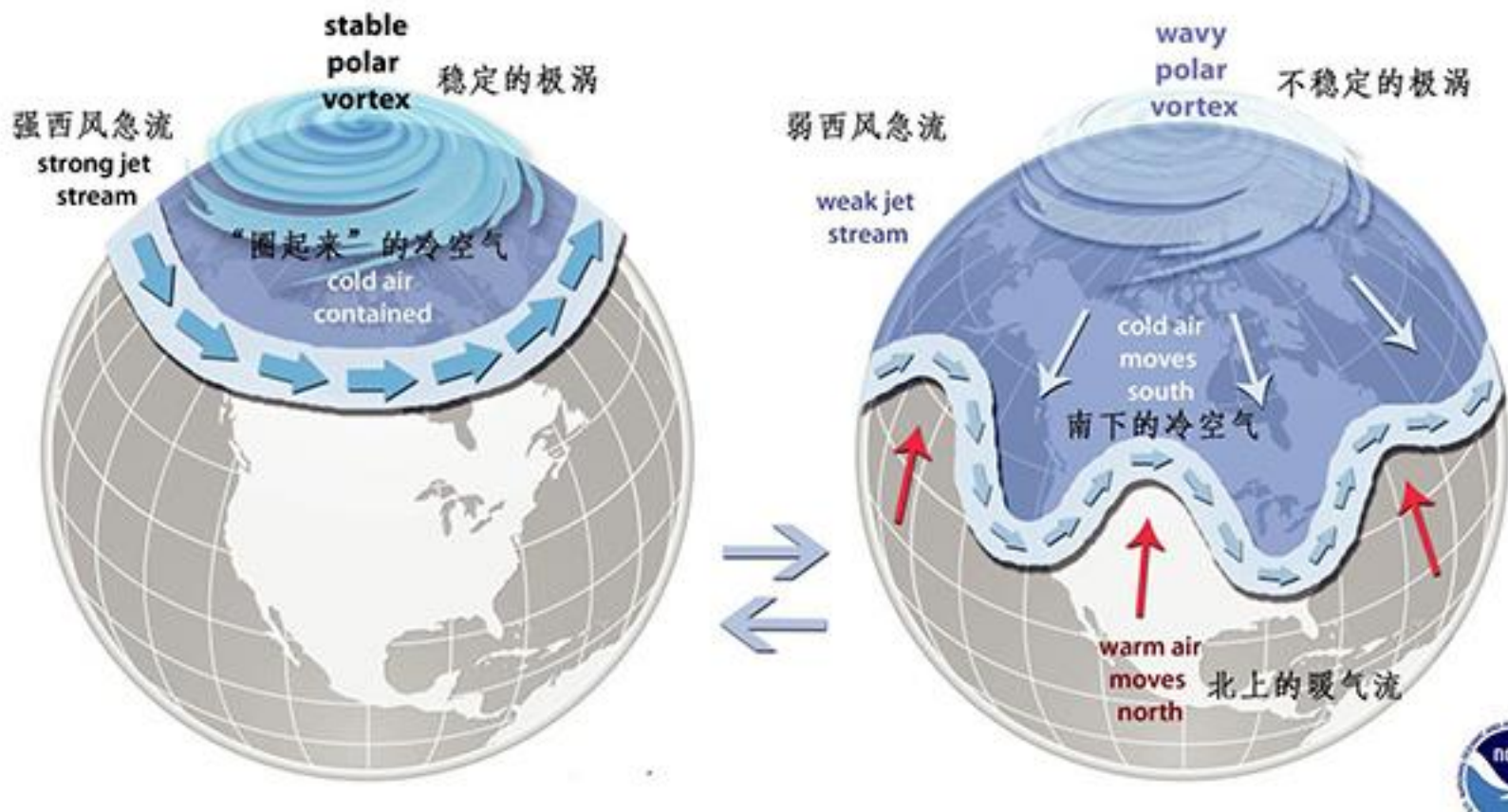

第四章 大气运动和大气环流

4.3 大气环流：全球

■ 三圈环流 西风急流

副热带西风急流：

- **位置**：冬季平均位于 $20-30^{\circ}\text{N}$ ，夏季平均位于 $35-50^{\circ}\text{N}$ 附近
- **强度**：在 $200-250\text{hPa}$ 上强度最强 & 冬季强于夏季

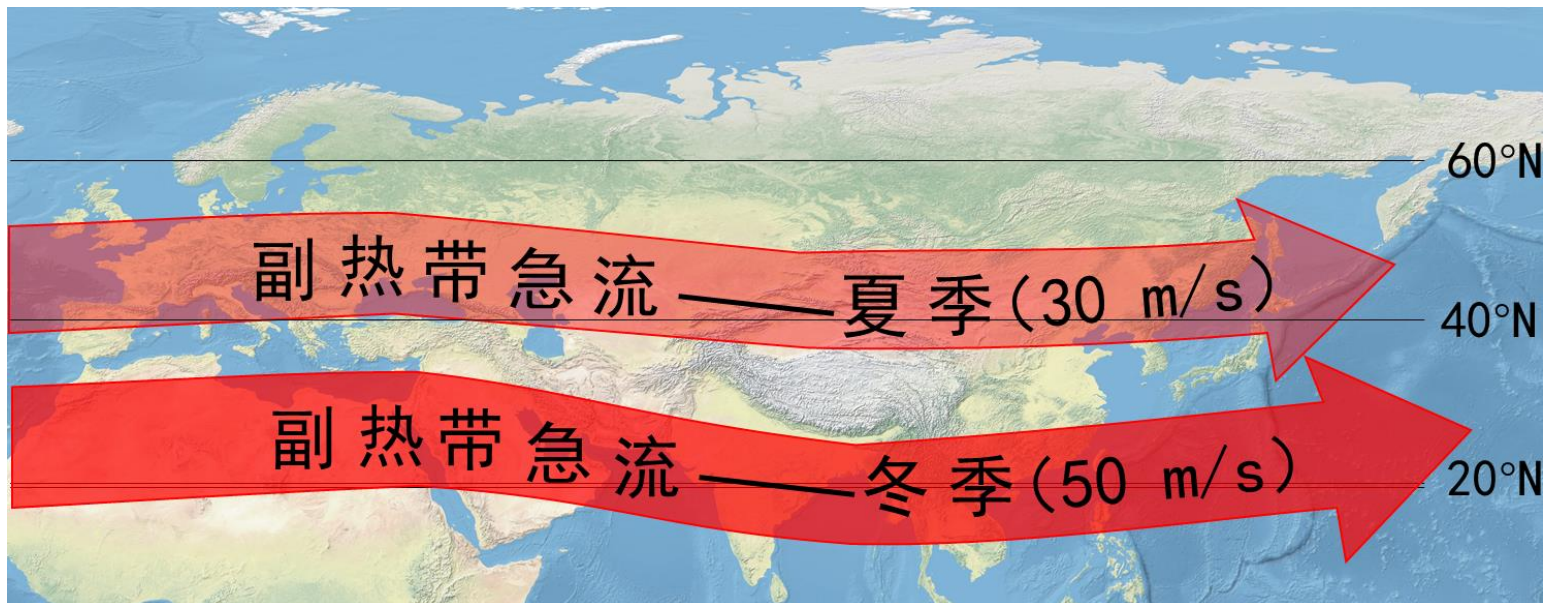

第四章 大气运动和大气环流

4.3 大气环流：全球

■ 三圈环流 西风急流

极锋急流：

- 位置：冬季平均位于 $40-60^{\circ}\text{N}$ ，夏季平均位于极圈附近
- 强度：在 $300-500\text{hPa}$ 上强度最强 & 冬季强于夏季

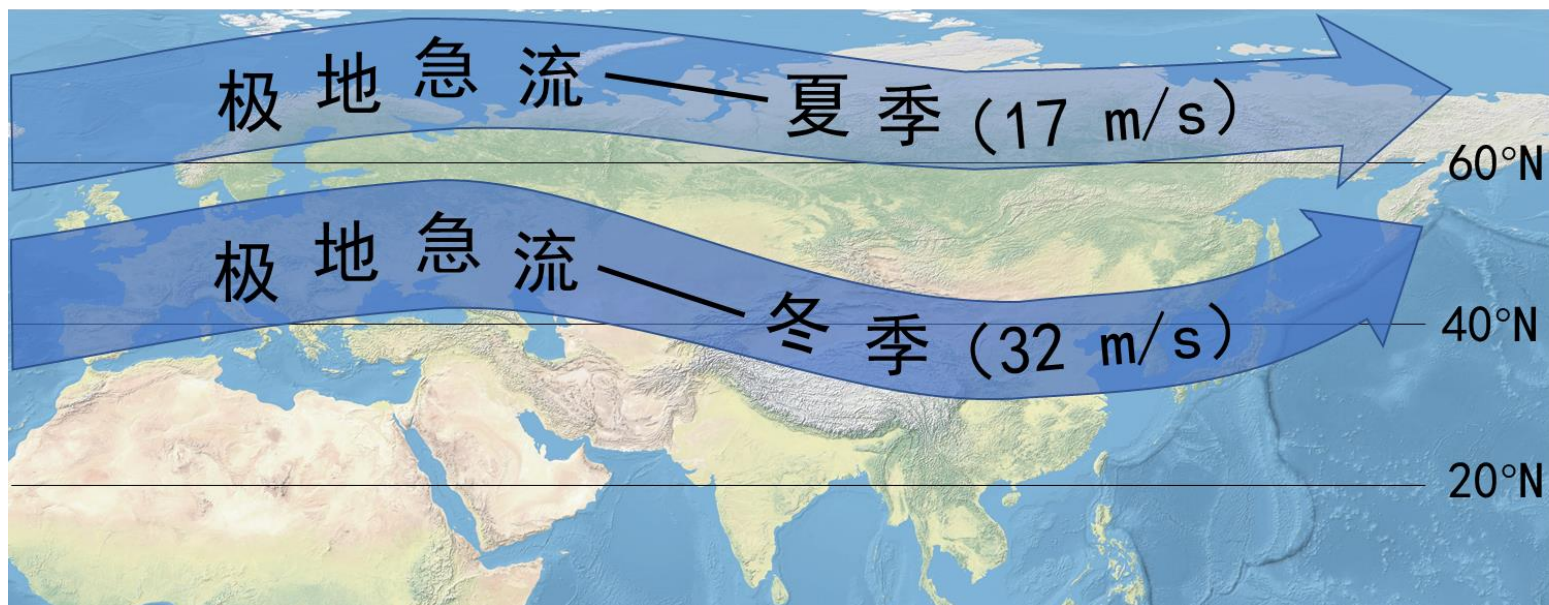

4.3 大气环流：全球

■ 三圈环流：不确定的问题

费雷尔环流 Ferrel circulation ?

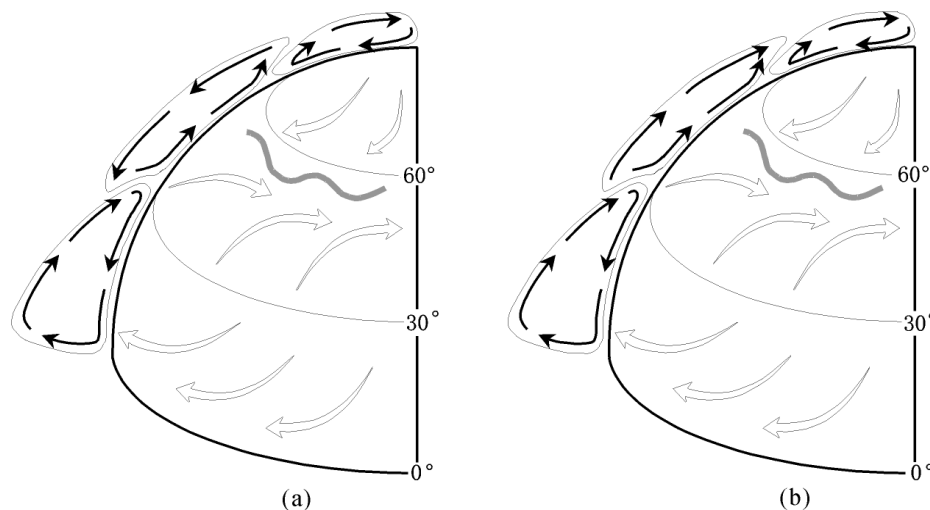
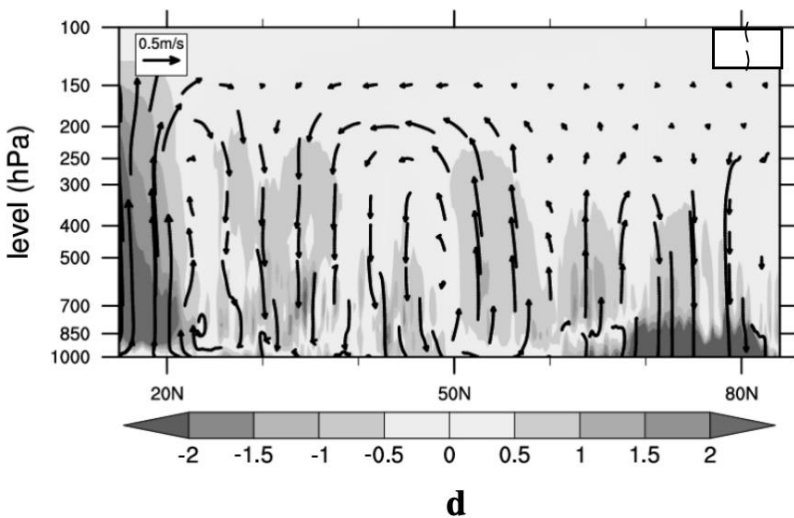
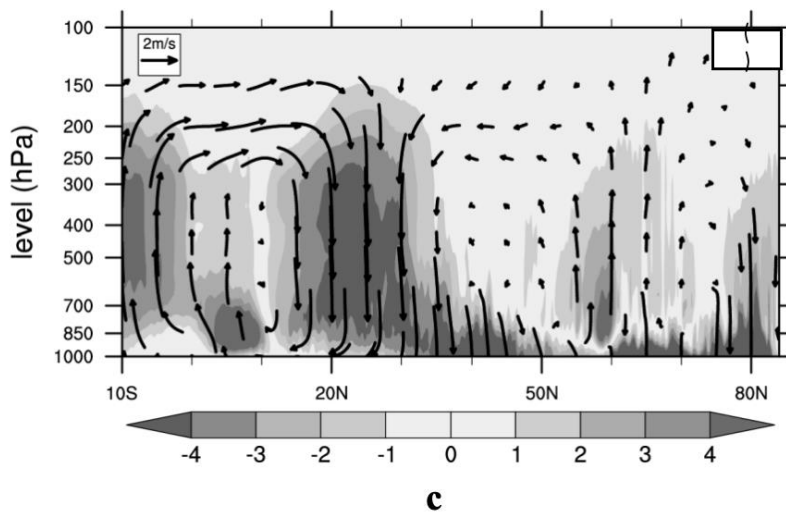
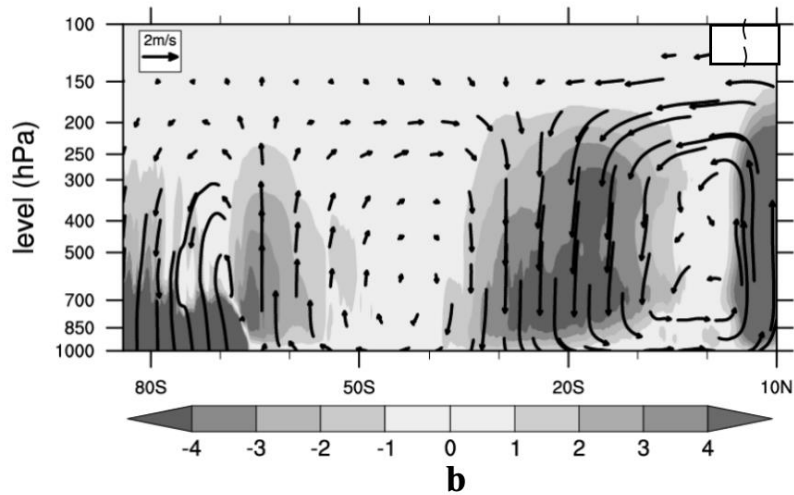
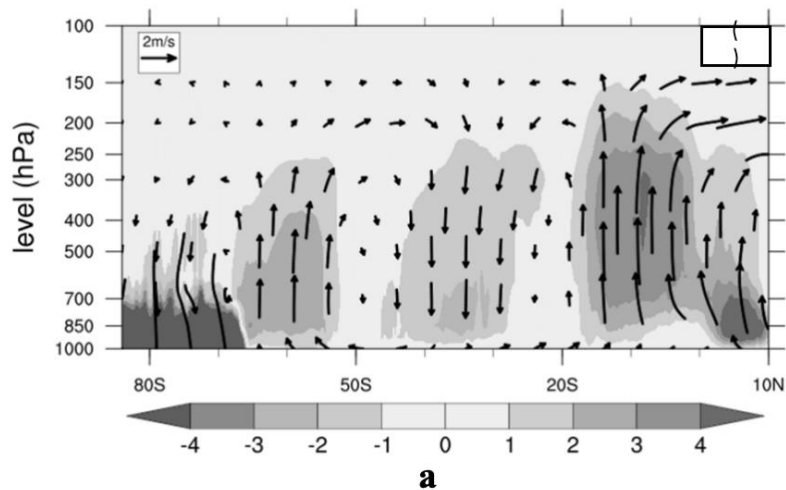

Fig. 1 (a) Classical three-cell model^[5~7]; (b) Three-cell model modified by Frederick^[9]
Only the northern hemisphere is shown. The thin lines with arrows denote the MMC and the wider ones indicate the wind directions in the lower troposphere. Note the directions of the upper flow between 30° ~ 60°.

判断冬天 or 夏天?



4.3 大气环流：全球

三圈环流：

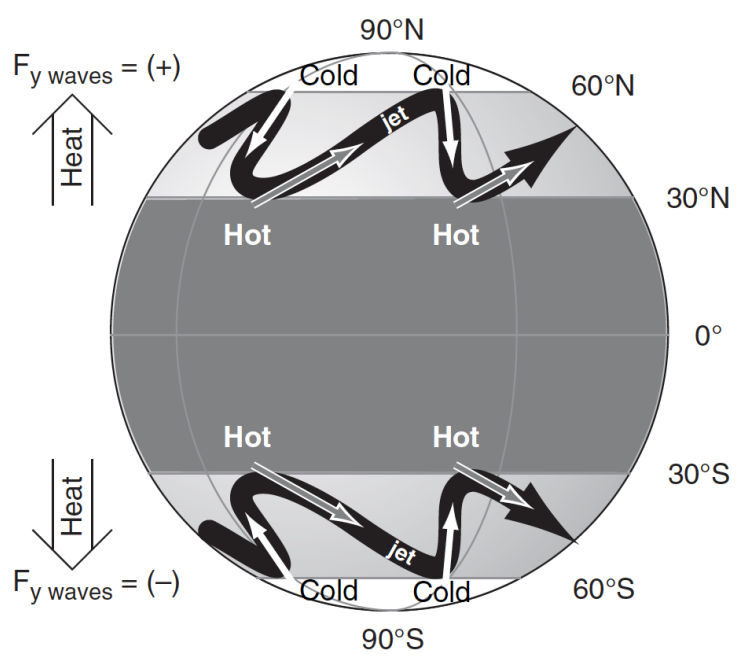

热输送

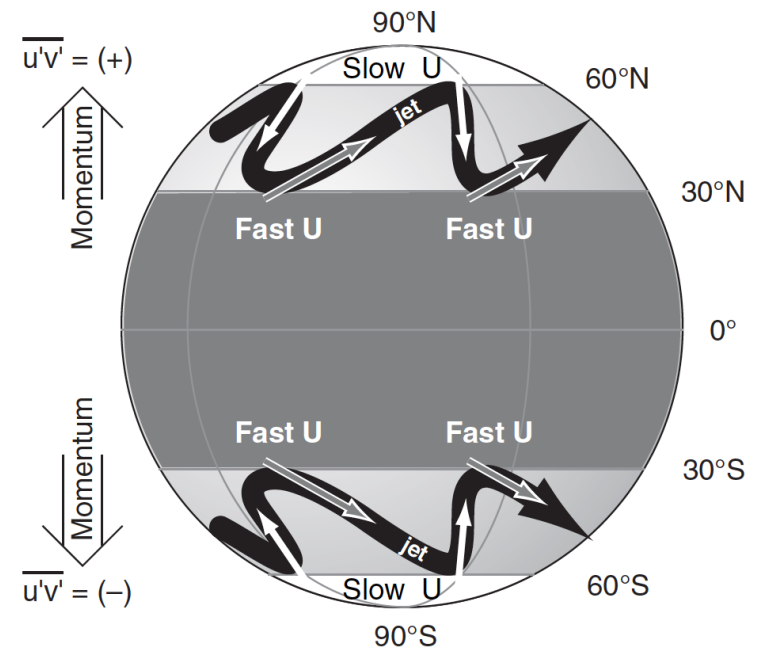

动量输送

4.3 大气环流：全球

■ 三圈环流：

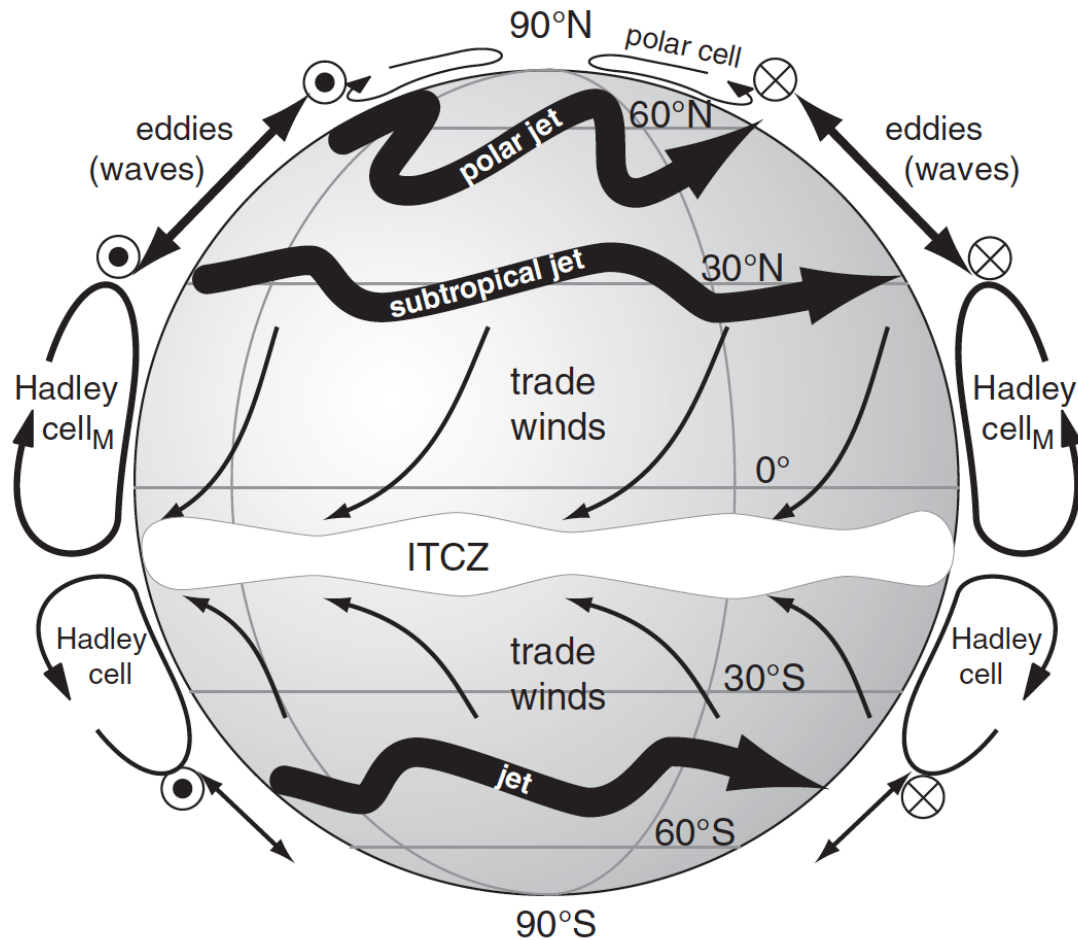

划重点！

- 哈德来环流是重点（赤道辐合带，副热带高压，信风，西风带，急流）
- 急流：冬夏季的差别；波导；不稳定扰动；位置/强度
- 全球变暖下的影响

第四章 大气运动和大气环流

4.3 大气环流：全球

■ 三圈环流 实际风场

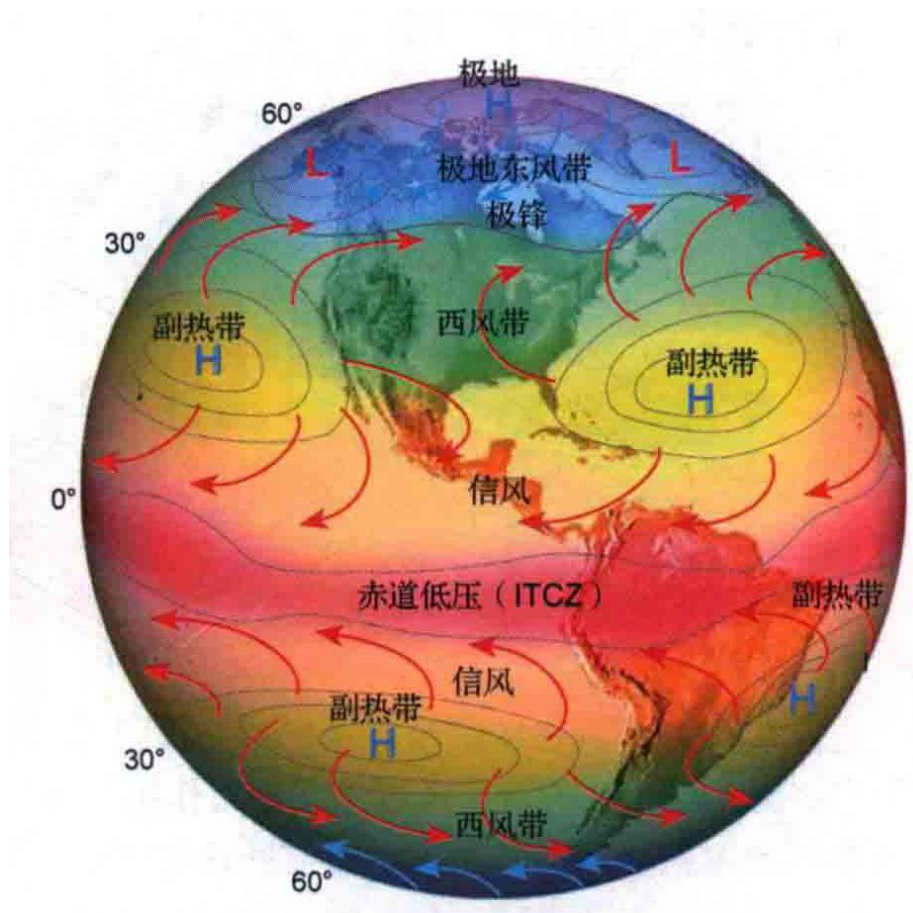

第四章 大气运动和大气环流

4.3 大气环流：全球低层风场

■ 地表不均的影响

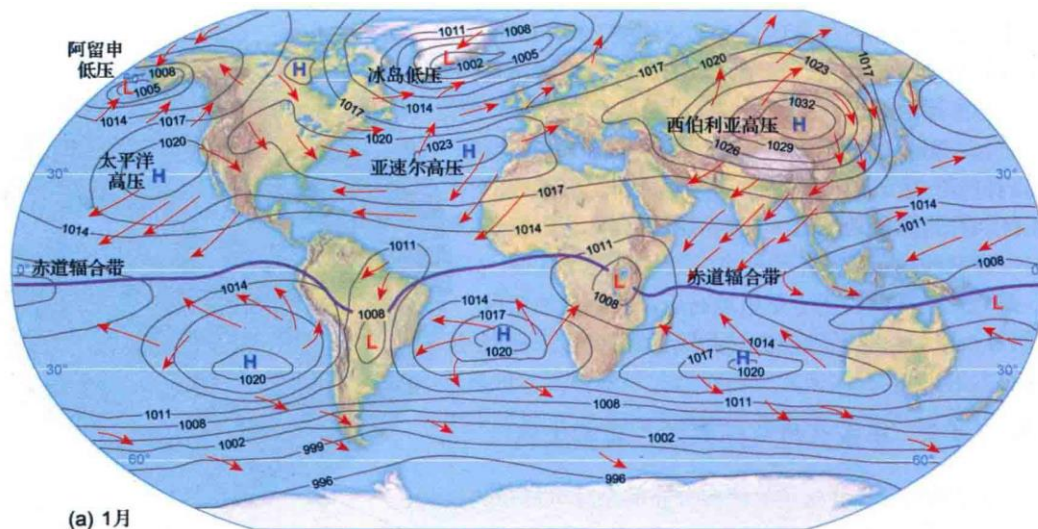

(a) 1月

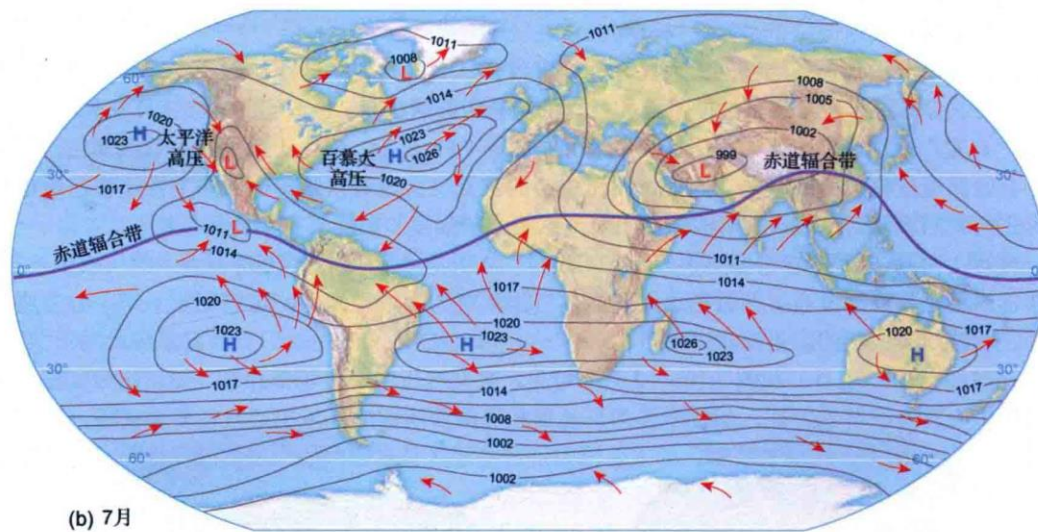

(b) 7月

▲图 7.10 全球海平面气压场和风场。(a)1月, (b)7月

第四章 大气运动和大气环流

4.3 大气环流：全球低层风场

■ 地表不均的影响

✧ **常年活动中心：**“三圈环流”

太平洋高压、大西洋高压，
阿留申低压、 冰岛低压；

✧ **季节活动中心：**与海陆热力差异有关

南亚低压、 北美低压、
西伯利亚高压、北美高压

第四章 大气运动和大气环流

4.3 大气环流：全球

■ 地表不均匀：低层大气

回忆知识点？

冷高压，热低压，是深厚还是浅薄系统？

第四章 大气运动和大气环流

4.3 大气环流：全球高层

■ 地表不均的影响

500hPa 1月等高线

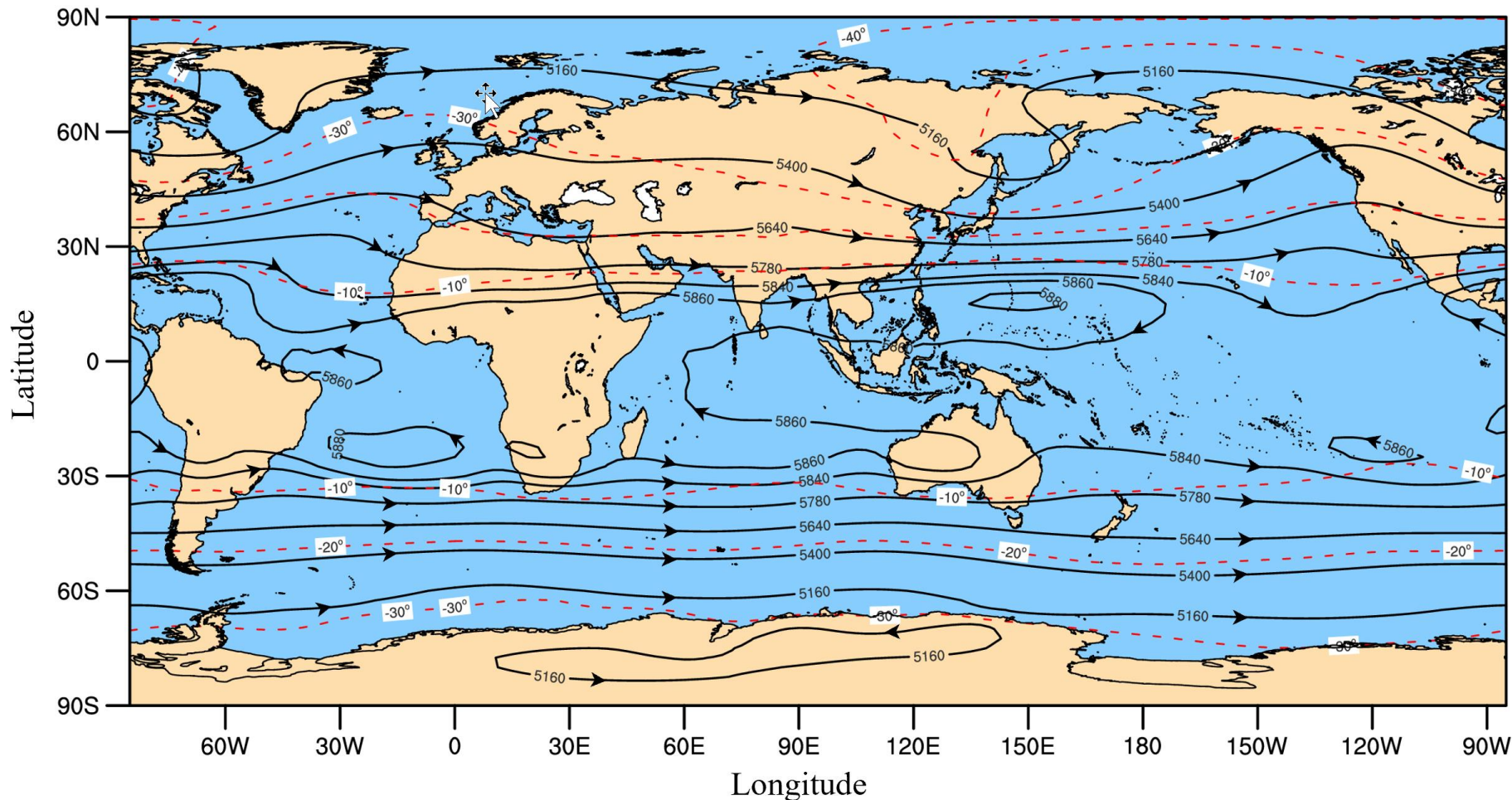

潘瑜娴绘制

第四章 大气运动和大气环流

4.3 大气环流：全球高层

■ 地表不均的影响 500hPa 7月等高线

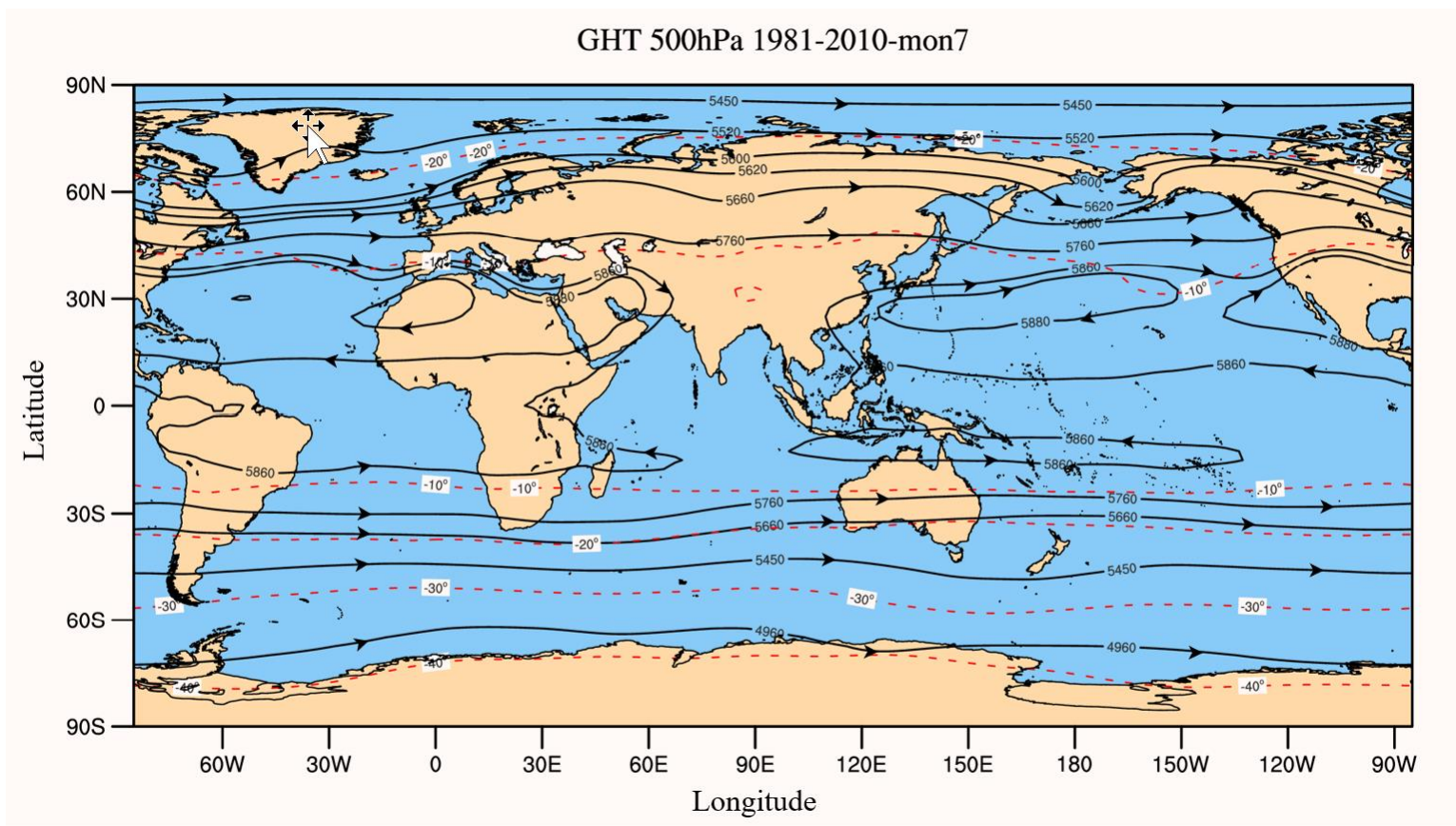

潘瑜娴绘制

第四章 大气运动和大气环流

4.3 大气环流：全球

■ 地表不均的影响

低层大气-全球区域季风

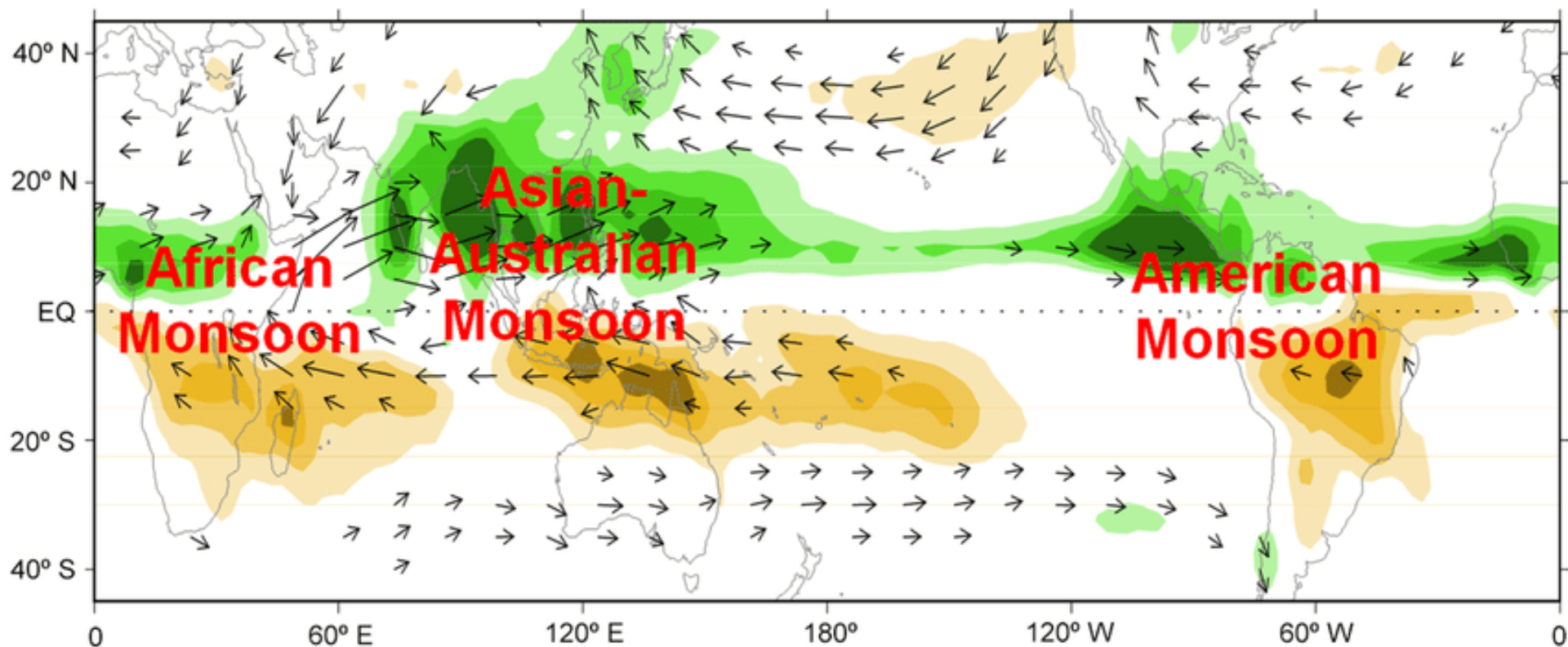

第四章 大气运动和大气环流

4.3 大气环流：全球

■ 地表不均匀影响：低层大气-季风

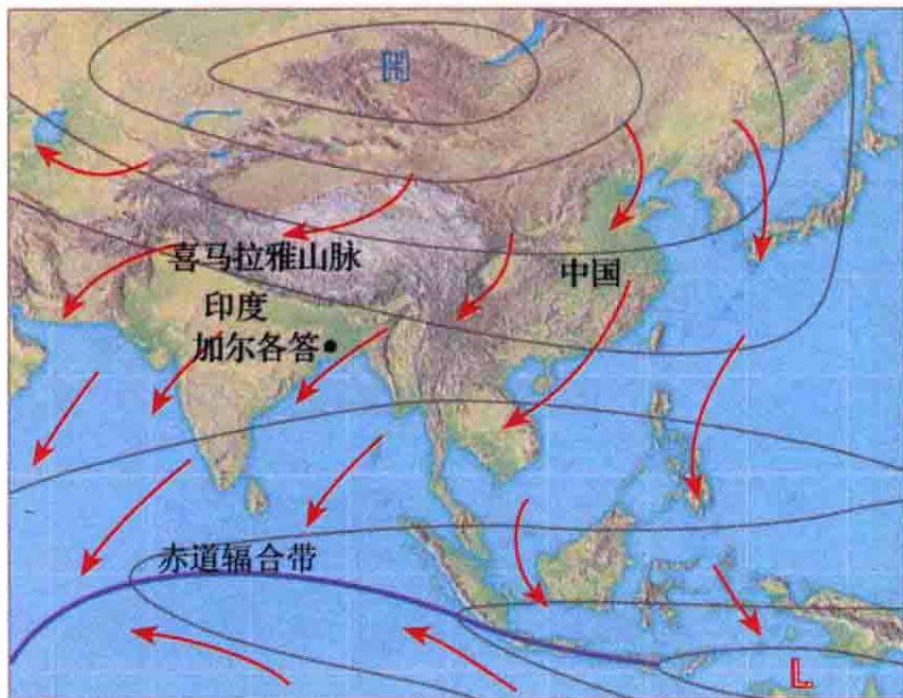

(a) 冬季风

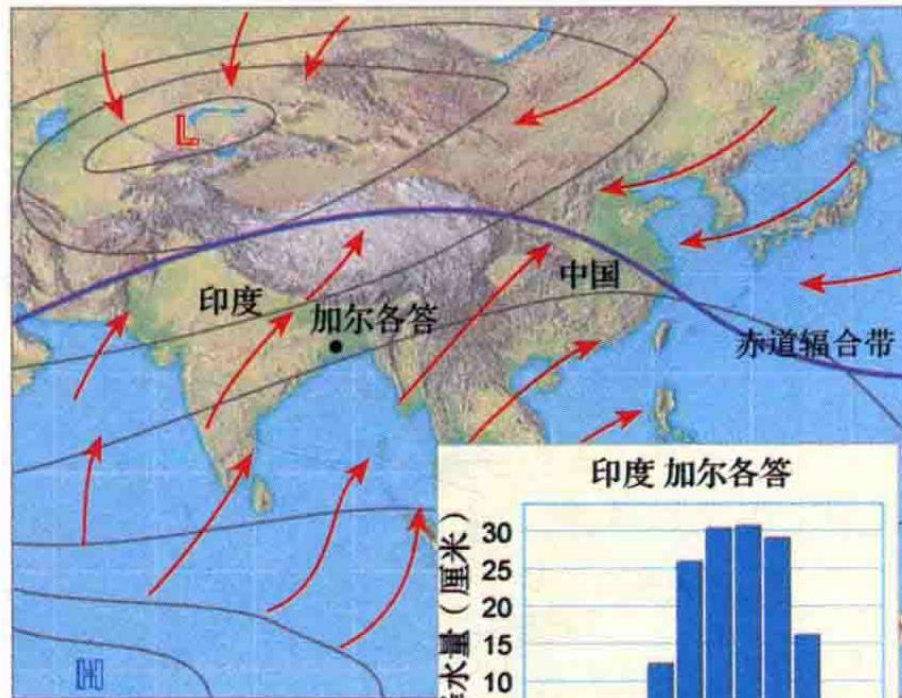

(b) 夏季风

季风指标: 降水

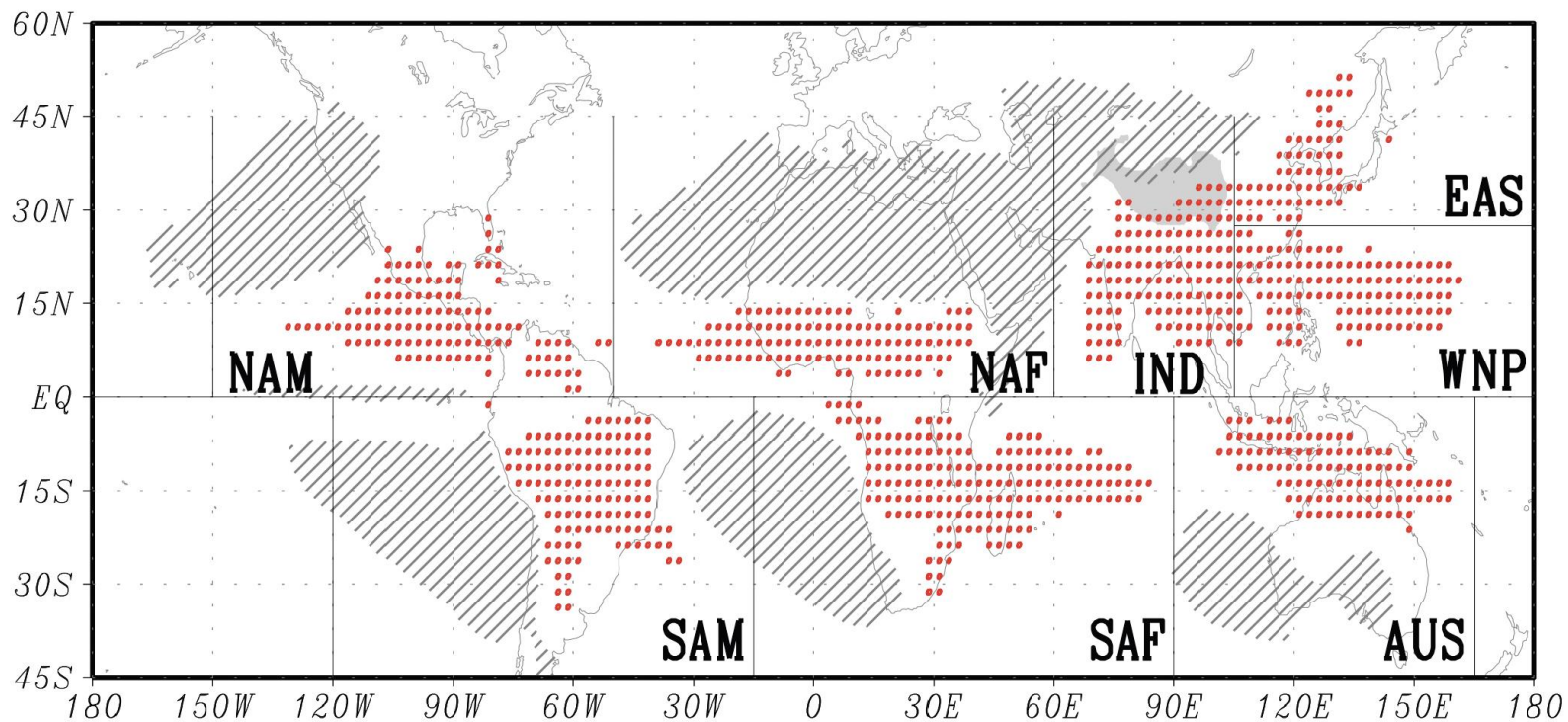

Figure 1: The approximate global monsoon precipitation domain is here defined where the local summer-minus-winter precipitation rate exceeds 2.5 mm/day and the local summer precipitation exceeds 55 % of the annual total (in red). During any individual year, it is possible for the monsoon to affect a broader area than shown here. Summer denotes May through September for the northern hemisphere and November through March for the southern hemisphere. The dry regions, where the local summer precipitation is less than 1 mm/day are hatched, and the 3000m height contour surrounding Tibetan Plateau is shaded. The merged Global Precipitation Climatology Project/Climate Prediction Center Merged Analysis of Precipitation precipitation data were used. These observations are based on rain gauge data over land and satellite data over the oceans. The regional monsoons are the North American monsoon (NAM), North African monsoon (NAF), Indian monsoon (IND), East Asian monsoon (EAS), Western North Pacific monsoon (WNP), South American monsoon (SAM), South African monsoon (SAF), and the Australian monsoon (AUS). This figure kindly provided by Prof. Bin Wang.

■ 季风指标: 近地面风

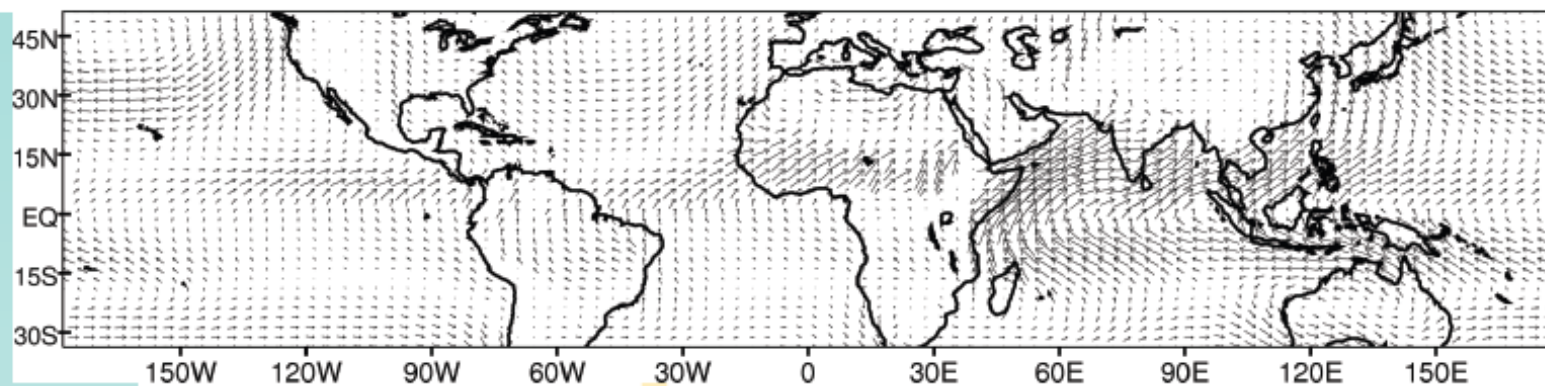
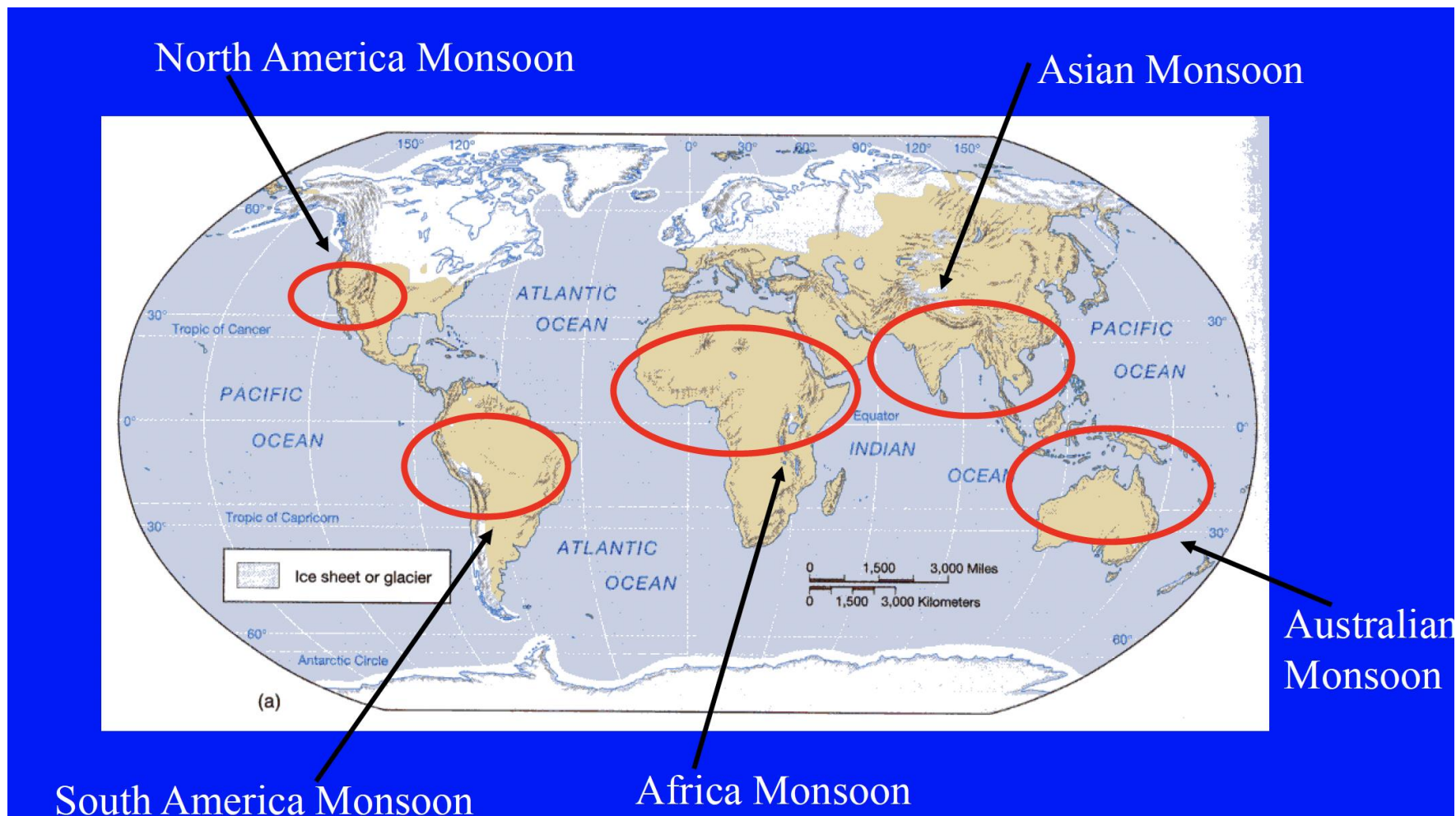

Figure 2: Seasonal change in lower tropospheric wind (925hPa) over the tropical monsoon regions (JJA minus DJF). Note the obvious reversal from north-easterly to south-westerly winds near West Africa and India from northern hemisphere winter to summer in the observations. This data is from the European Centre for Medium-Range Weather Forecasts 40-year Reanalysis project. This figure kindly provided by Dr. Andy Turner.

第四章 大气运动和大气环流

4.3 大气环流：全球

■ 地表不均匀影响：低层大气-季风



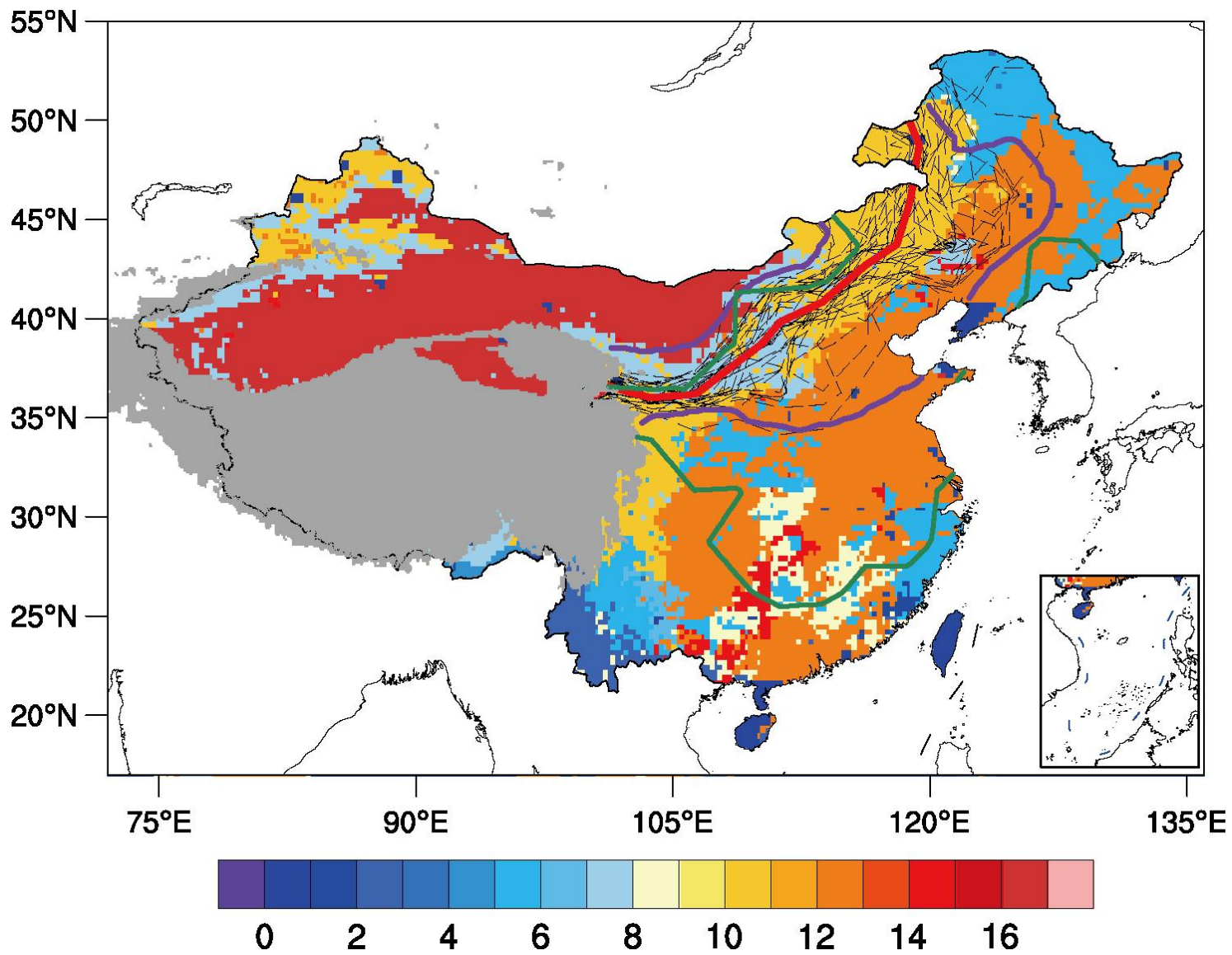

5-9月 300mm等降水线

第四章 大气运动和大气环流

4.3 大气环流：全球

■ 下垫面不均影响：热带纬圈环流 Walker 环流

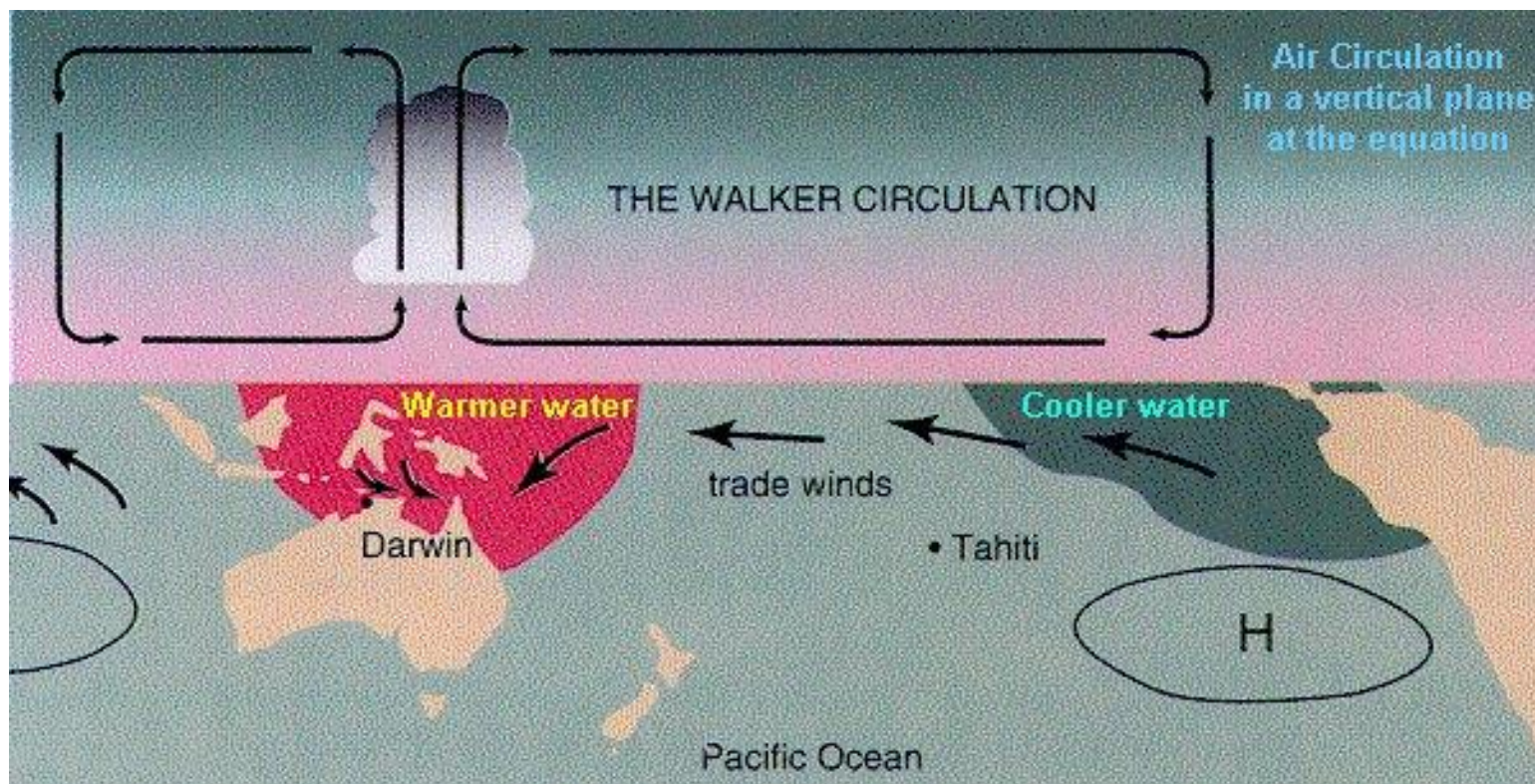

(from Flohn (1971))

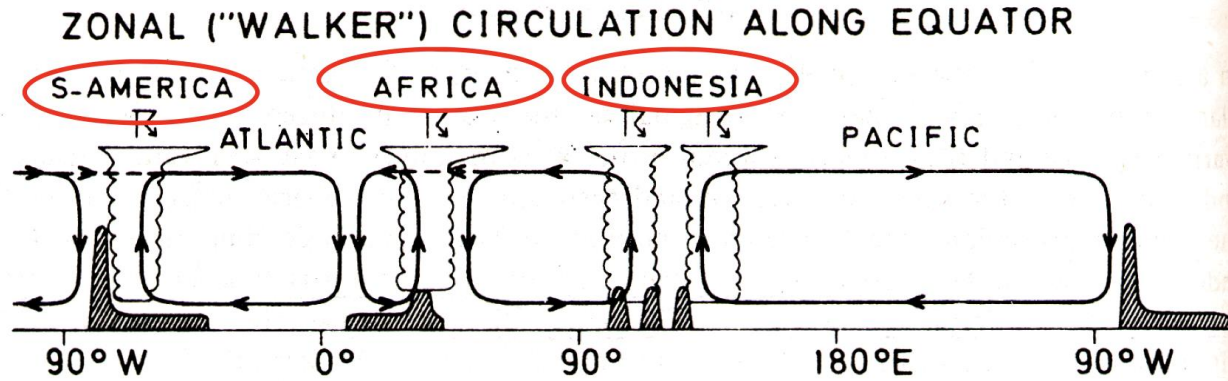

Southern Oscillation: an atmospheric phenomenon

In 1910s, Walker found a connection between barometer readings at stations on the eastern and western sides of the Pacific (Tahiti and Darwin). He coined the term **Southern Oscillation** to dramatize the ups and downs in this east-west seesaw effect.

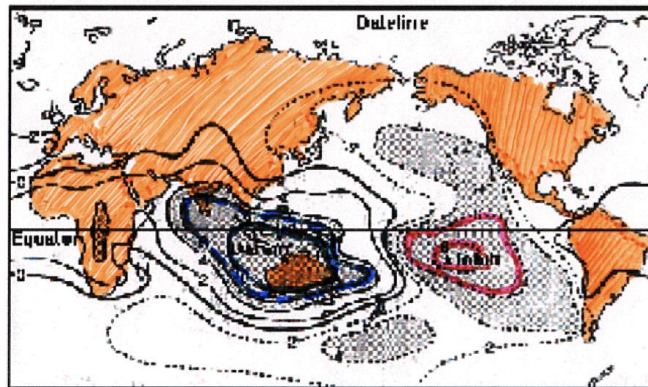

(from Rasmusson 1984)

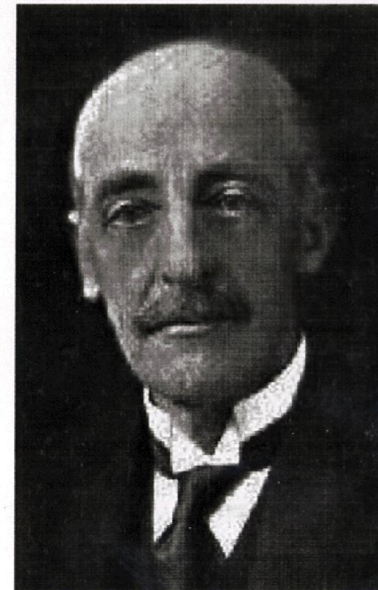

Sir Gilbert Walker

Normal Conditions

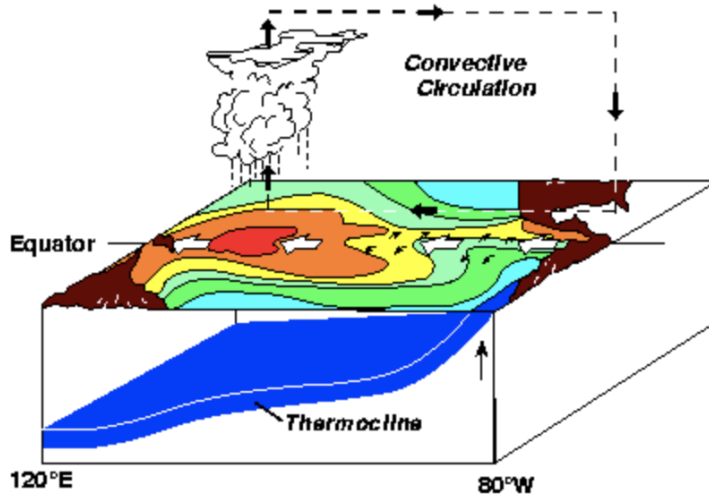

El Niño Conditions

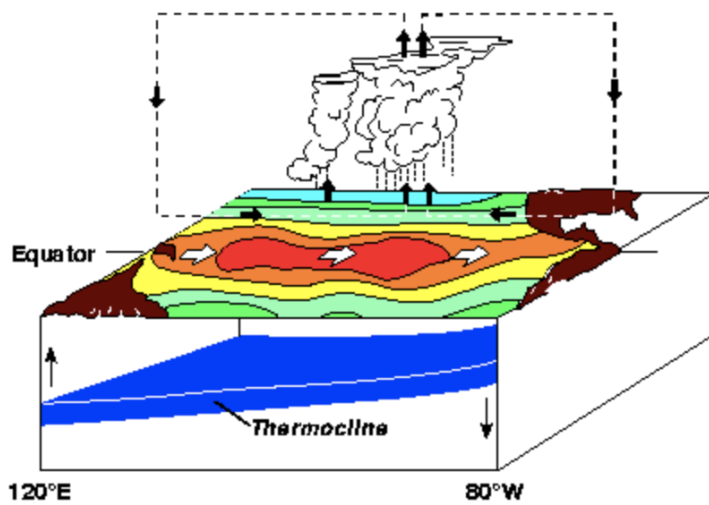

La Niña Conditions

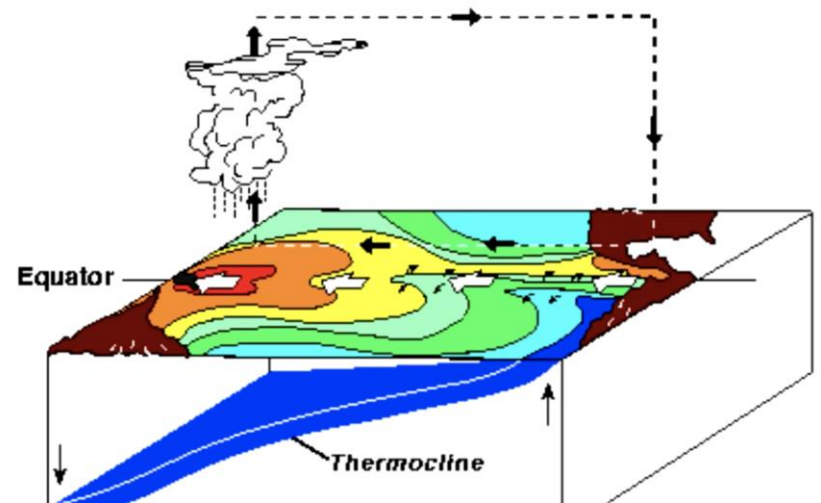

第四章 大气运动和大气环流

4.3 大气环流：全球

■ 高大地形的作用



第四章 大气运动和大气环流

4.3 大气环流：全球

■ 高大地形的作用

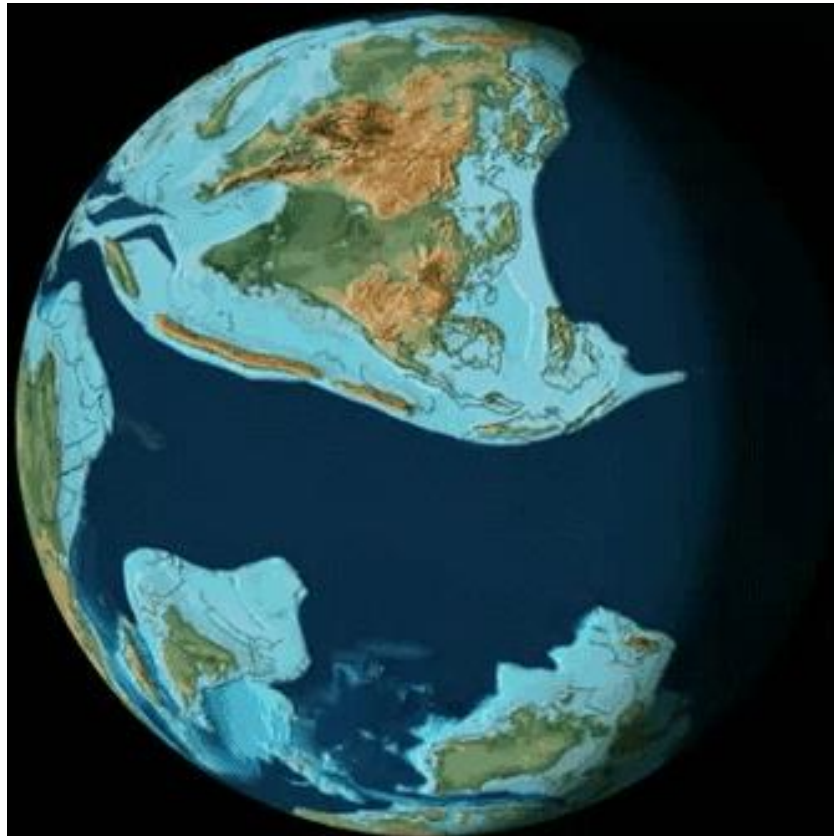

第四章 大气运动和大气环流

4.3 大气环流：全球

■ 高大地形的作用：青藏高原

近代青藏高原气象学的开拓者 - 叶笃正先生

叶笃正 院士
(1916-2013)
Rossby学生



吴国雄 院士

第四章 大气运动和大气环流

4.3 大气环流：全球

■ 高大地形的作用：青藏高原

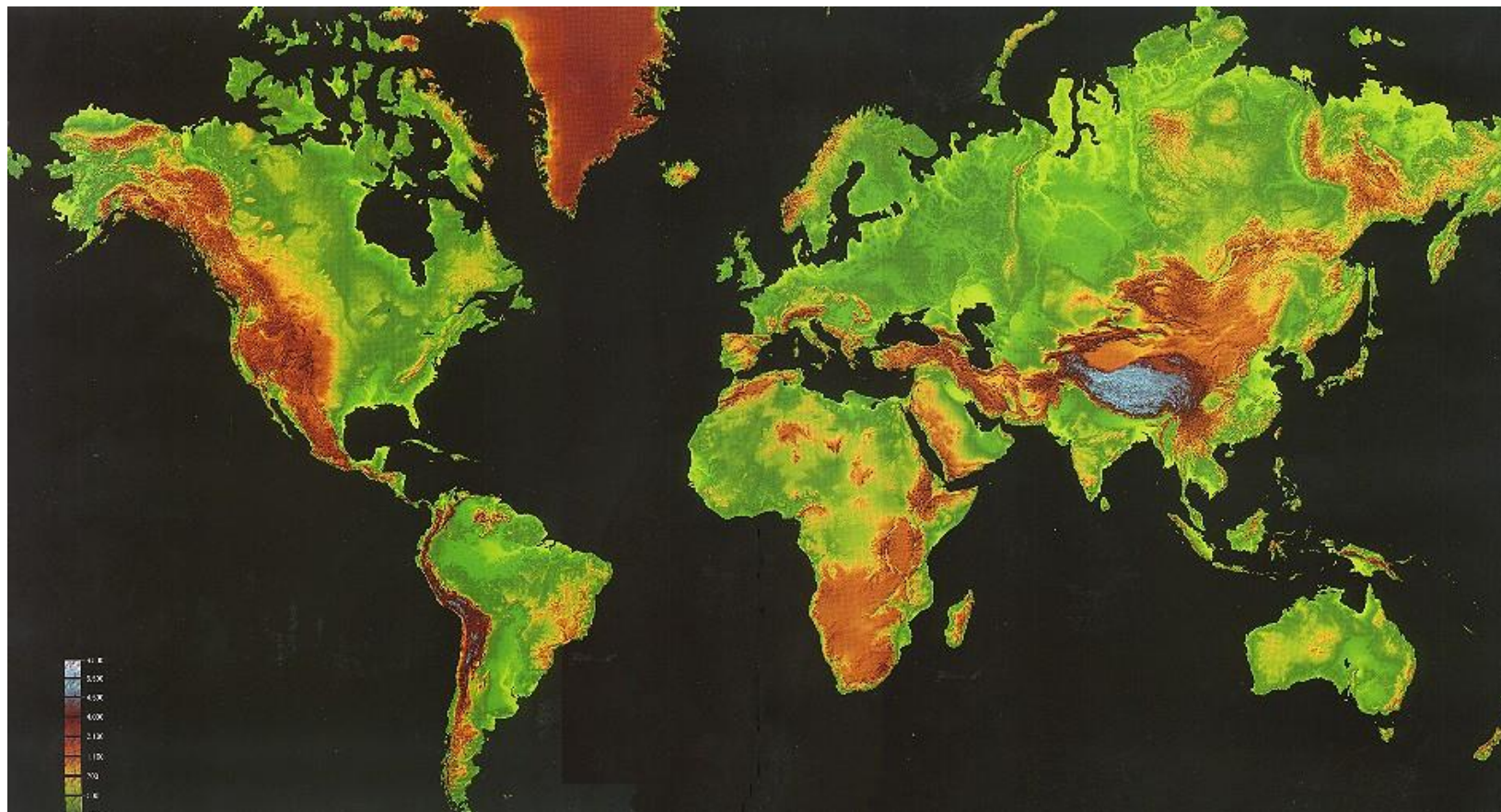



3000米河滩阶地



布达拉宫的闪电



5000米以上冰川



高寒
草甸

第四章 大气运动和大气环流

4.3 大气环流：全球

■ 高大地形的作用：动力作用（冬季）

绕流

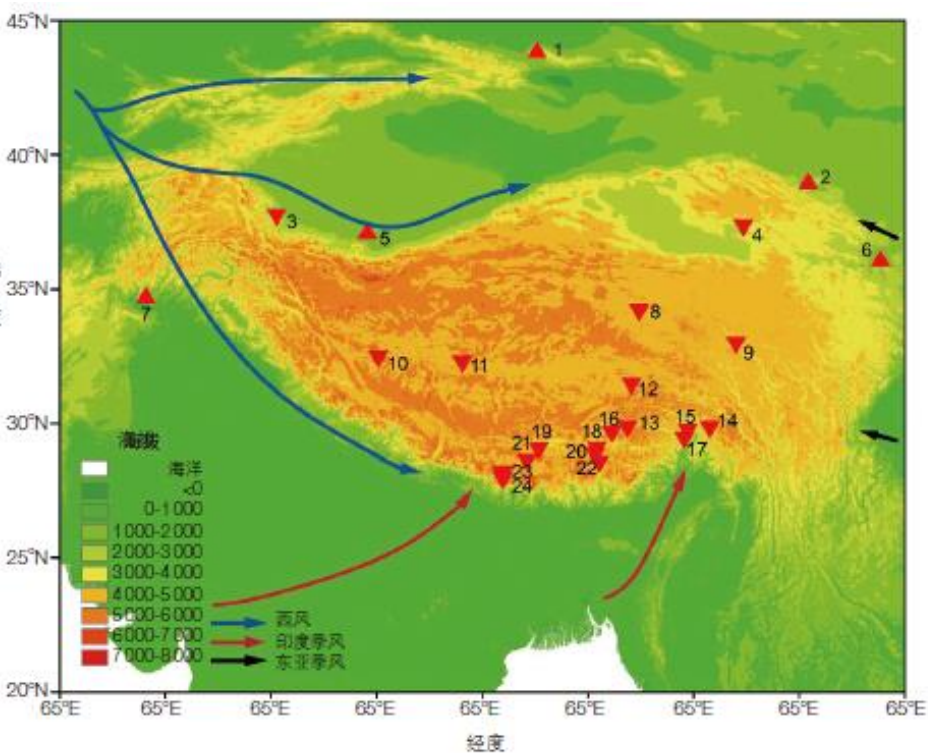

阻挡

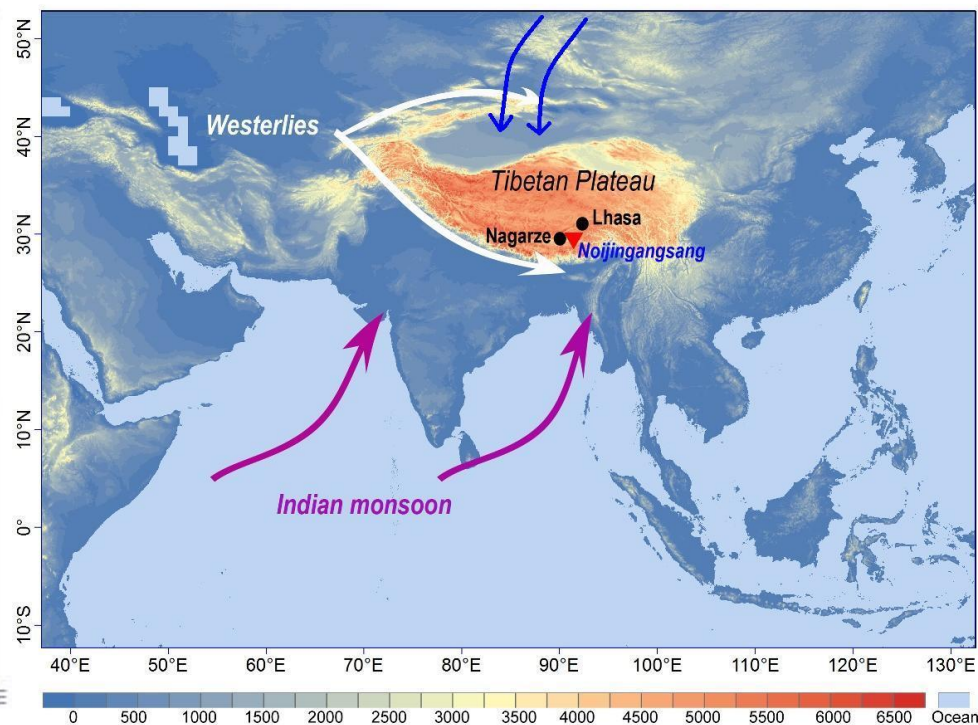

第四章 大气运动和大气环流

4.3 大气环流：全球

■ 高大地形的作用：动力作用（冬季）

爬升

迎风坡→质量辐合→ 高压脊

背风坡→质量辐散→ 低压槽

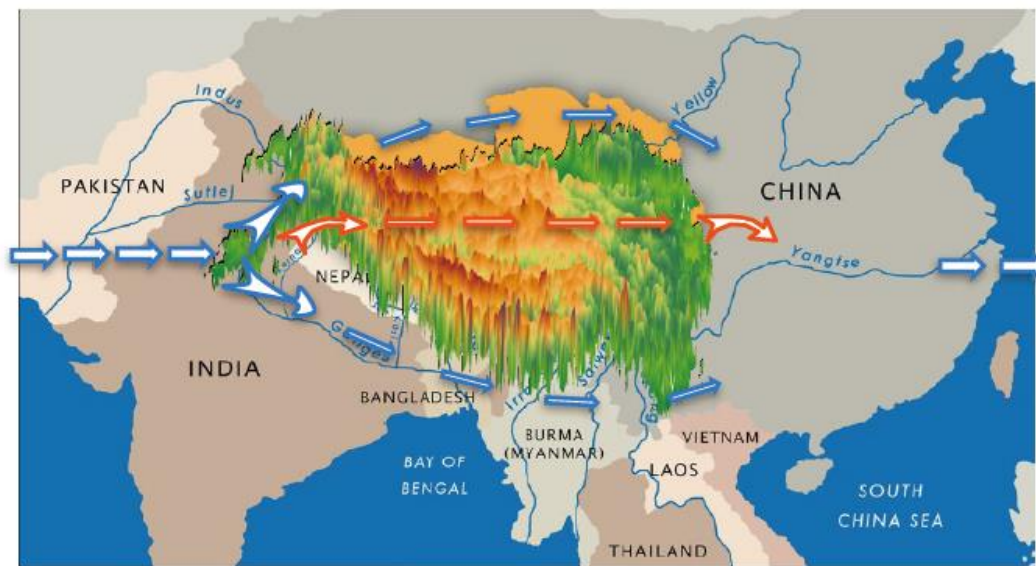

Yeh, Tellus, 1950

4.3 大气环流：全球

■ 高大地形的作用：热力作用（夏季）

- 相对于同纬度同高度的大气而言，夏季是热源，冬季是冷源，增加了海陆热力对比。
- 对南亚和东亚季风环流的形成、发展和维持有重要影响。

第四章 大气运动和大气环流

4.3 大气环流：全球

■ 高大地形的作用：热力作用（夏季）

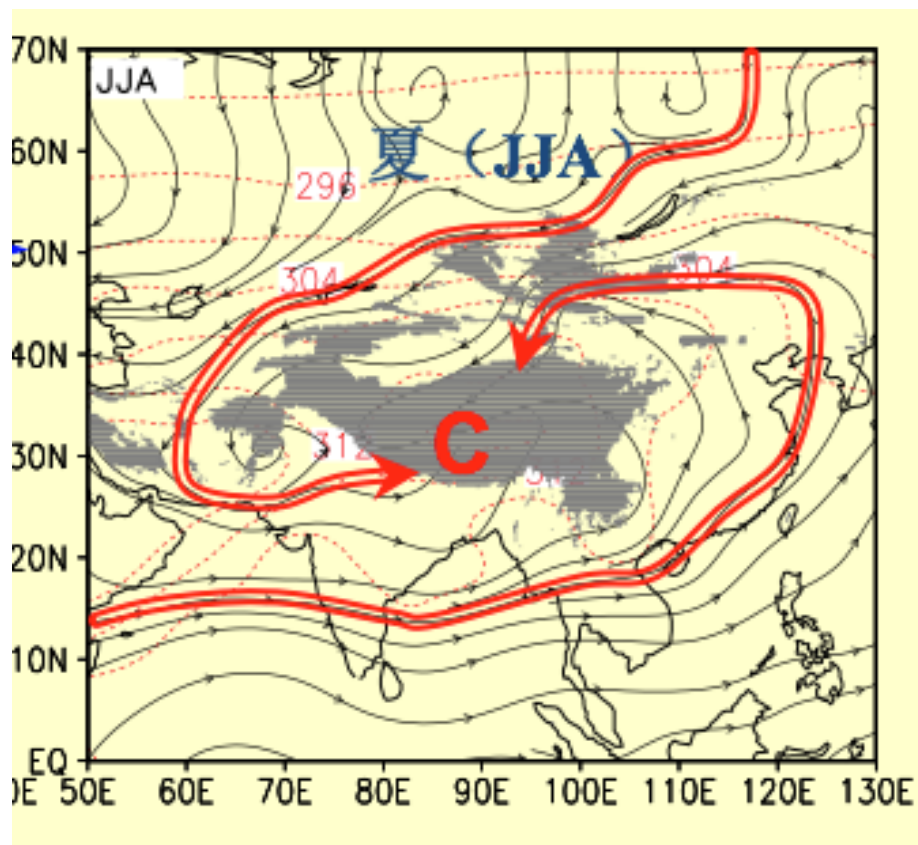

Summer: Warm Spiral

第四章 大气运动和大气环流

4.3 大气环流：全球

■ 高大地形的作用：热力作用与亚洲季风区

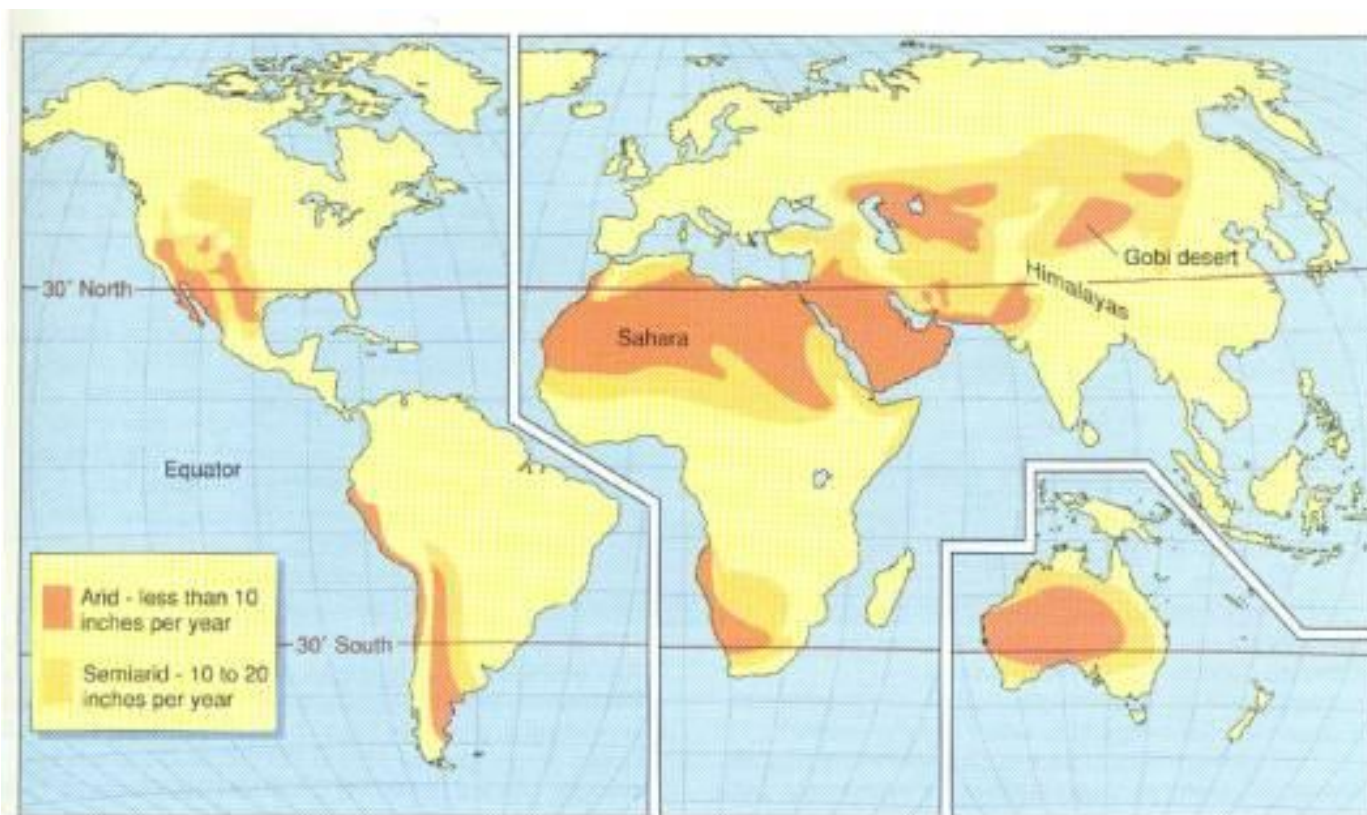

Global Distribution of Deserts

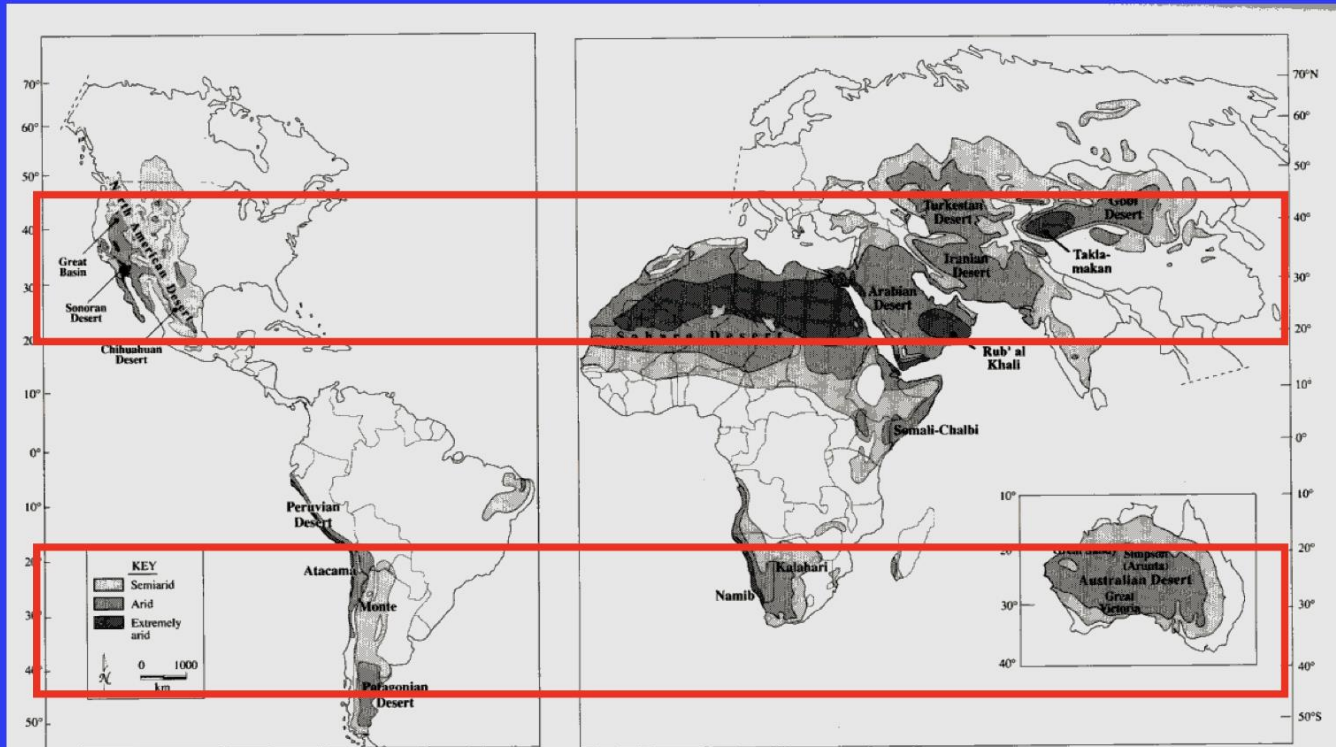

Fig. 6.21 Map showing arid lands around the world. Meigs classification taken from *Mosaic* magazine (Vol. 8, Jan/Feb 1977). [See McGinnies *et al.*, eds., (1968). Permission granted by the Office of Arid Lands Studies.]

(from *Global Physical Climatology*)

“Monsoon Debate”

• 季风之争

动力为主还是热力为主？

Uncertainty comes from:

Coarse resolution of model

Lack of observation

Different developing phase of monsoon



Peaks of contention. Modeling climate in the Himalayas and other mountainous regions is notoriously difficult.

The rhythms of life across South Asia depend on the Indian monsoon. Climate scientists are locking horns over the cause of the summer deluges

BEIJING—The Tibetan Plateau is a study in extremes. It's the world's largest expanse of elevated terrain, covering 2.5 million square kilometers. Frigid in winter, it bakes in summertime: Because the average altitude tops 4000 meters, the vast landscape absorbs far more solar energy than land at sea level. As a result, models predict that in summer, the air layer above the plateau can be much warmer than air at a similar altitude over the oceans or over land lying at sea level.

It's like “having a gigantic heat pump at over 4000 meters,” says Wu Guoxiong, an atmospheric scientist at the Chinese Academy of Sciences' Institute of Atmospheric Physics here. The temperature differential is the engine that drives the spectacular summer deluges in South Asia known as the Indian monsoon—or so say textbooks. A new spate of research is challenging existing dogma, sparking a debate over the Tibetan Plateau's role in the Indian monsoon. How it's decided could have effects reaching far beyond the climate science community.

At stake are how to “predict when [the monsoon] will start, how long it's going to last, and how it will respond to rising carbon dioxide and aerosols,” says David Battisti, a climate scientist at the University of Washington, Seattle. “That matters hugely to millions of people.” A resolution could prove elusive, however, because of the challenges of modeling climate in mountainous regions.

This much is agreed upon: In the summer, the air over and around Tibet is much

warmer than air at the same altitude over the Indian Ocean. Consensus breaks down on whether that heating effect has broad consequences. In the 1950s, atmospheric scientists Ye Duzheng and Hermann Flohn independently proposed that the temperature differential creates winds that blow moist air from the sea into the interior of the Indian subcontinent. There, the air warms and rises, creating monsoonal rains. The hypothesis, which has stood for decades, is supported by climate modeling: The mon-



Dueling theorists. Wu (right) says the “heat pump” of the Tibetan Plateau drives the Indian monsoon. Boos (left) disagrees.

soon's strength—the total rainfall on the Indian subcontinent, that is—and how far north it reaches are greatly reduced when Tibet and the Himalayas are removed from climate models.

But those modeling studies have got it wrong, argues William Boos, a climate scientist at Yale University. They fail to “distinguish the role of the Himalayas from that

of the Tibetan Plateau,” he says. In 2008, he and Zhiming Kuang, then both at Harvard University, after examining temperature and humidity records in India and Tibet, uncovered what they claim are inconsistencies in the monsoon paradigm. One is that the upper atmosphere in the region is hottest over northern India and along the Himalayan ridge—not over Tibet. The finding “contradicts the view that Tibet is the heat center,” says Peter Molnar, a geoscientist at the University of Colorado, Boulder. Secondly, Boos and Kuang showed that this hot air blankets the land surface with the highest energy level—a calculation based on temperature and the energy released by water vapor when it rises and condenses into liquid. That means heating of the Indo-Gangetic Plain, rather than Tibet, is driving the monsoon, Boos argues.

Supporters of a diminished role for the Tibetan Plateau also point to precipitation models, which hold that the hotter the surface is and the more moisture it contains, the more likely it is that water vapor will rise. Heat is released as water vapor condenses and rain falls, thereby transferring the energy of air near the surface to the upper atmosphere. More water vapor means a warmer upper atmosphere—exactly what Boos and Kuang saw.

In a series of papers, the most recent of which appeared in February in *Scientific Reports*, the two scientists argue that Tibet is irrelevant to the Indian monsoon. Instead, they say the monsoon is caused by a “barrier effect”: the Himalayas blocking cold, dry winds from the north. In a global climate model, the duo showed that the Himalayas alone could generate a monsoon pattern that is largely similar to that pattern predicted when the Tibetan Plateau is included. When the mountain ranges were absent, they ended up with much lower energy in the air over northern India and got a weaker monsoon.

To further support their hypothesis, the researchers tweaked the model such that the Tibetan Plateau reflected all incoming solar radiation back into space, without heating the atmosphere. This “effectively turned off the heating source of Tibet without changing the Himalayas' blocking effect,” Boos says. The result: The monsoon pattern hardly budged.

第四章 大气运动和大气环流

4.3 大气环流：局地

■ 高大地形的作用：逆Hadley环流（夏季）

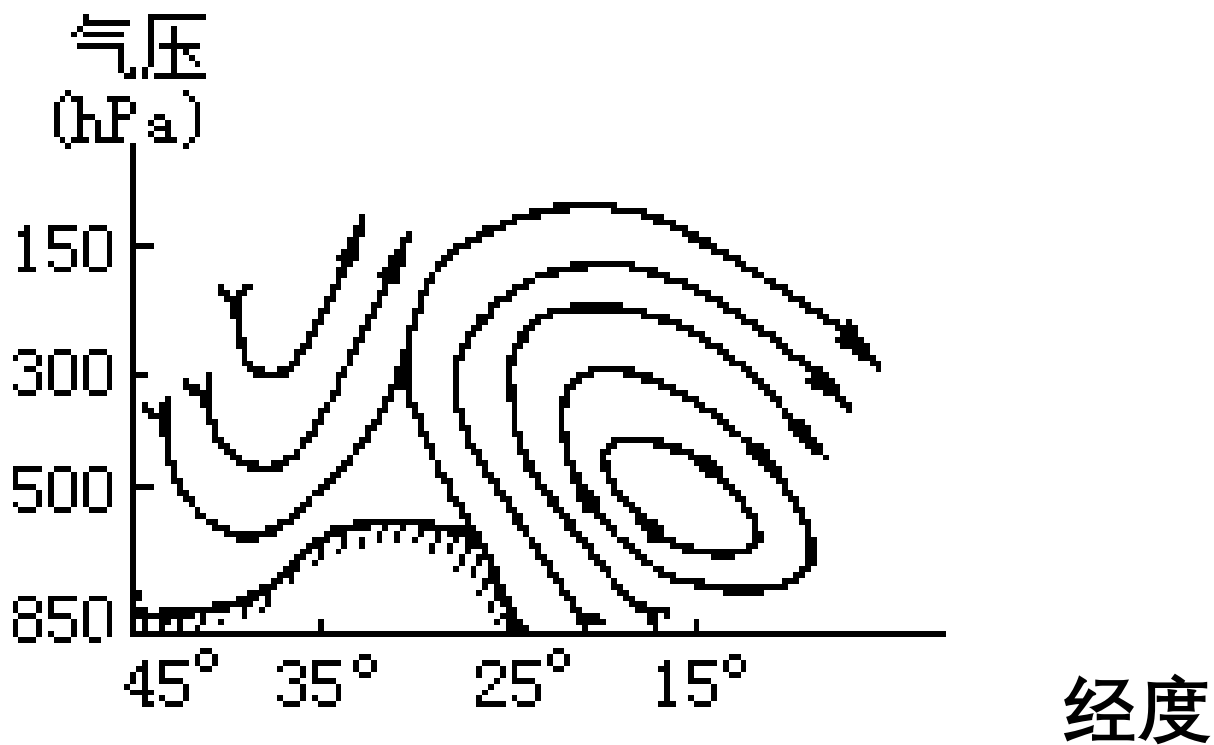

第四章 大气运动和大气环流

4.3 大气环流：局地

■ 海陆风

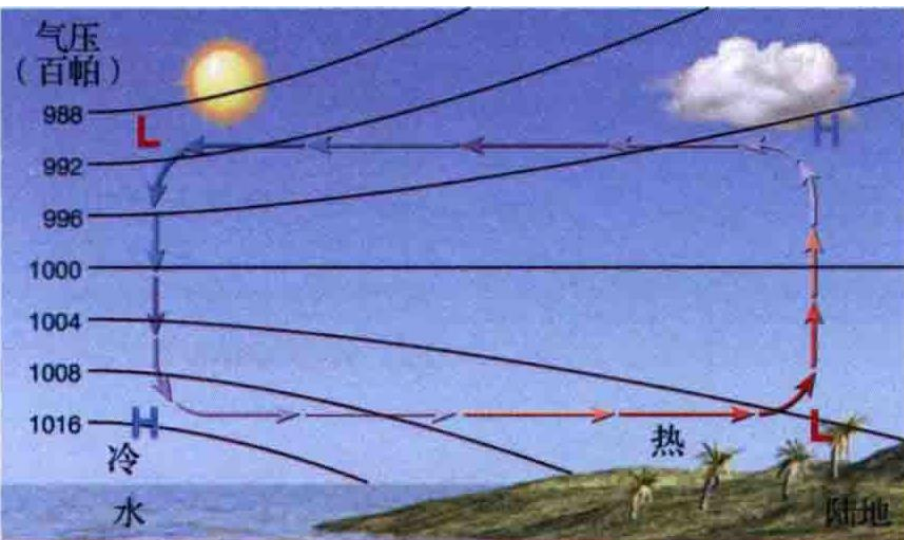

(a) 海风

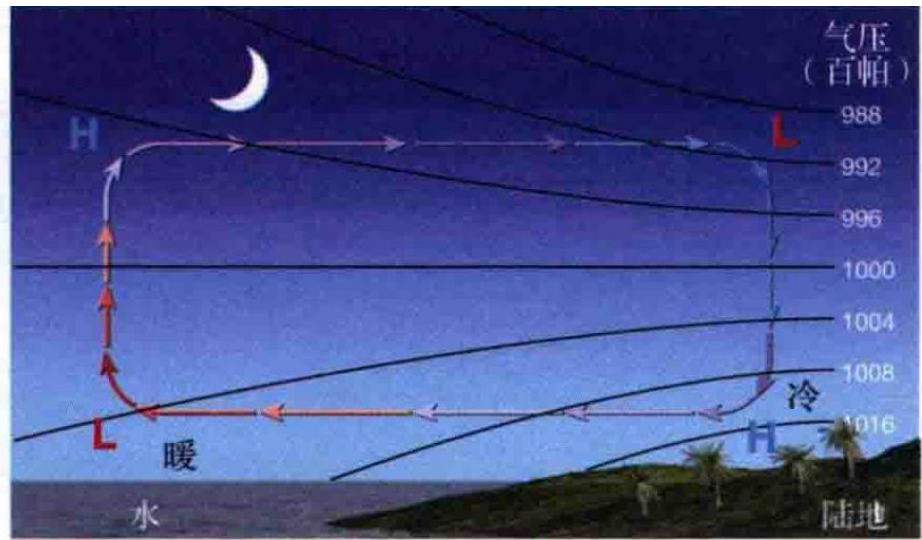

(b) 陆风

第四章 大气运动和大气环流

4.3 大气环流：局地

■ 山谷风

白天山坡上的空气被加热上升形成谷风

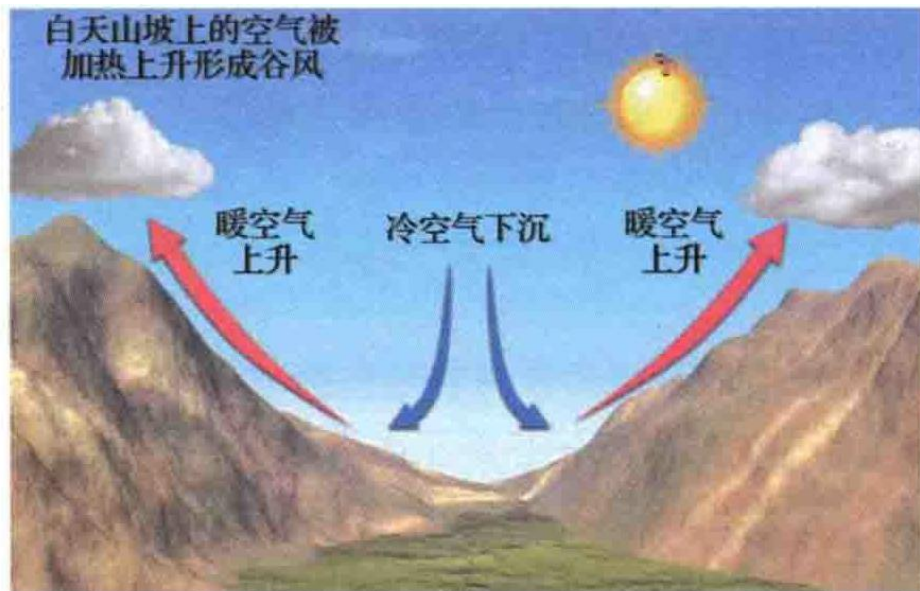

(a) 谷风

夜间山坡上的空气快速冷却流向较暖的谷底形成山风

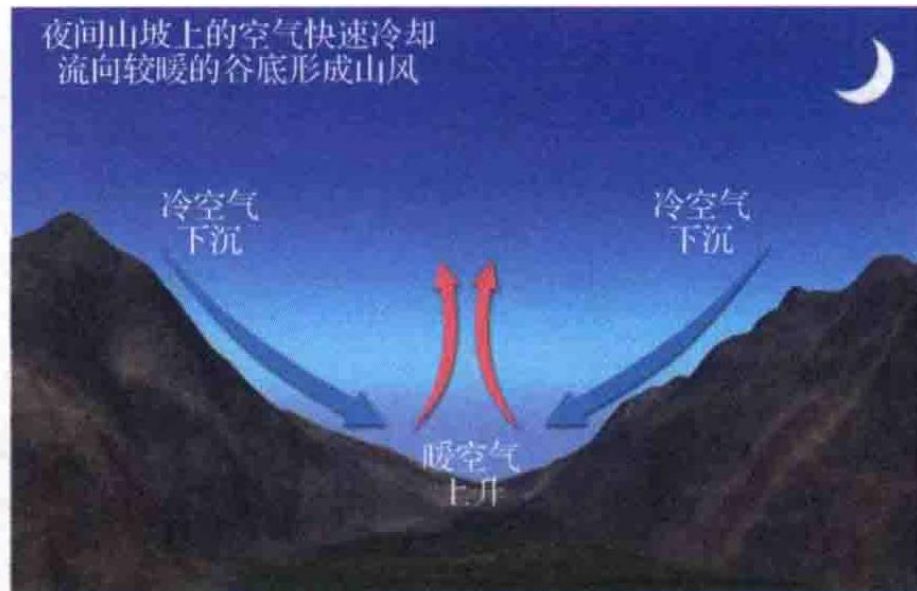

(b) 山风

第四章 大气运动和大气环流

4.3 大气环流：局地

■ 山谷风

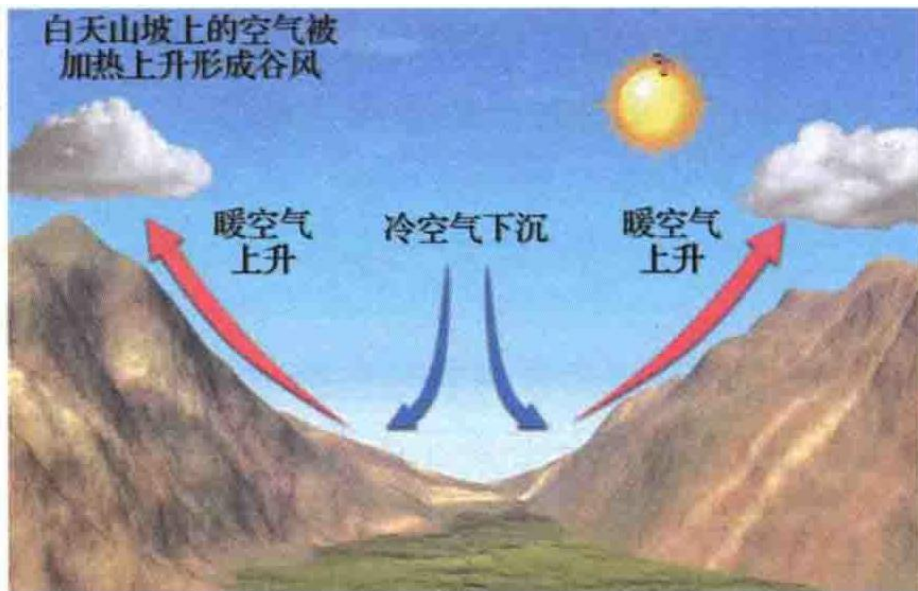

(a) 谷风

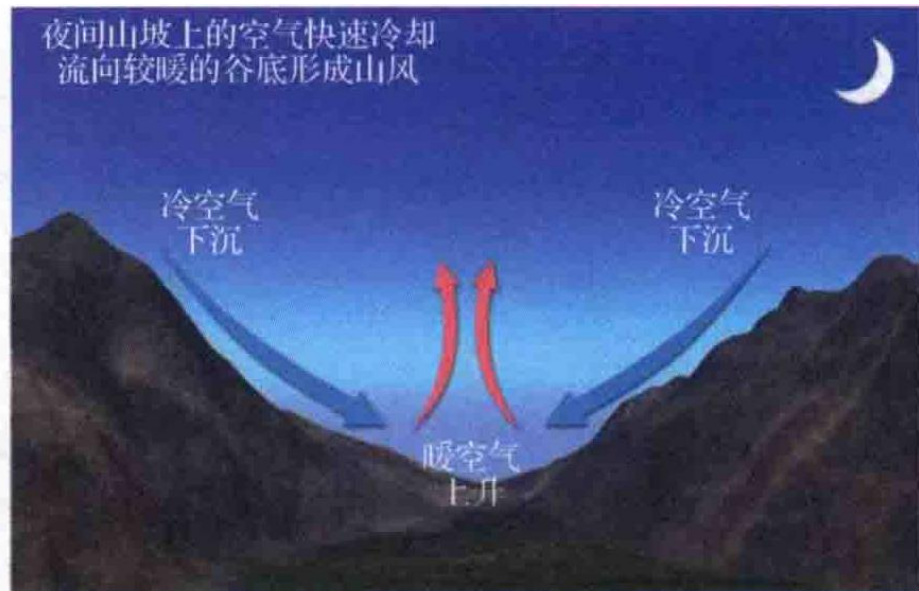

(b) 山风

何当共剪西窗烛，却话巴山夜雨时。

-李商隐 《夜雨寄北》

第四章 大气运动和大气环流

4.3 大气环流：局地

■ 下坡风：焚风（暖）

气流翻过山岭时在背风坡绝热下沉而形成干热的风



“高压锅”

2021年美西的热浪

拉斯维加斯

“沙漠赌城”

4.3 大气环流：局地

■ 下坡风（冷）

毗邻高原的地区会出现一种冷性的下坡风，密度很大的冷空气移动会产生下坡风，受重力影响，寒冷空气会像瀑布一样急剧下滑，造成破坏力的影响。

如格陵兰冰原和南极洲

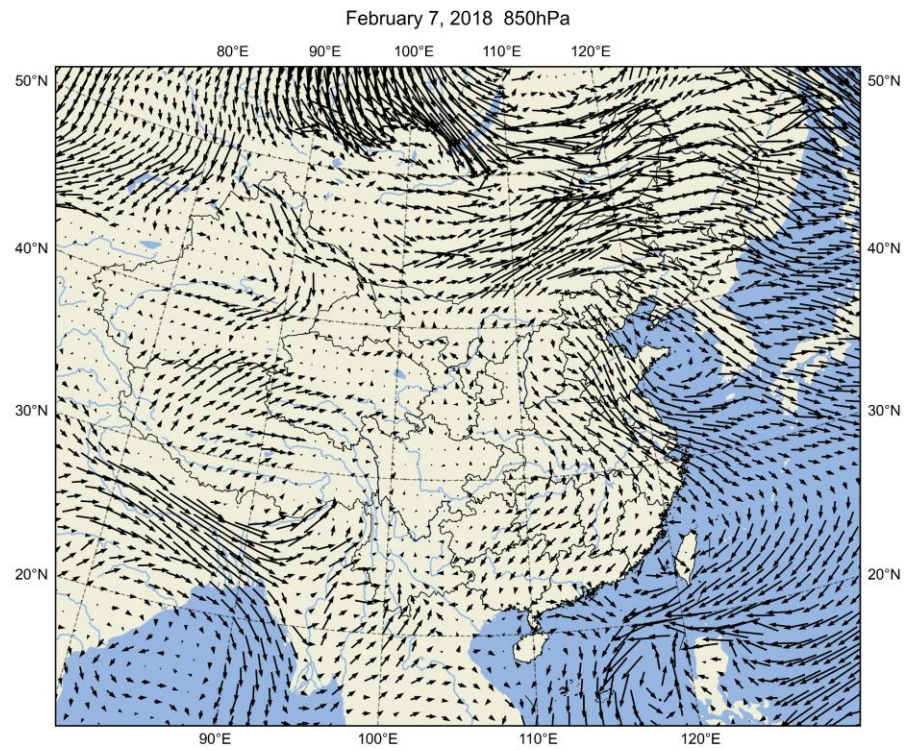
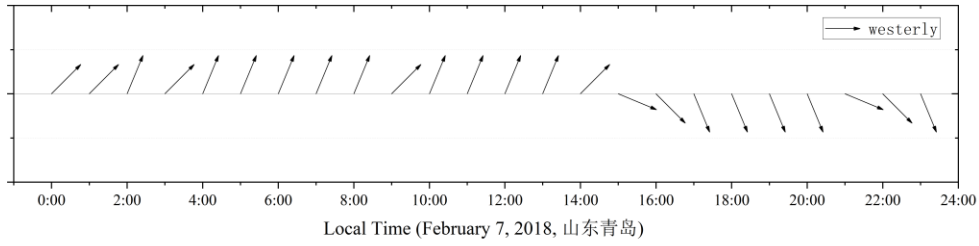

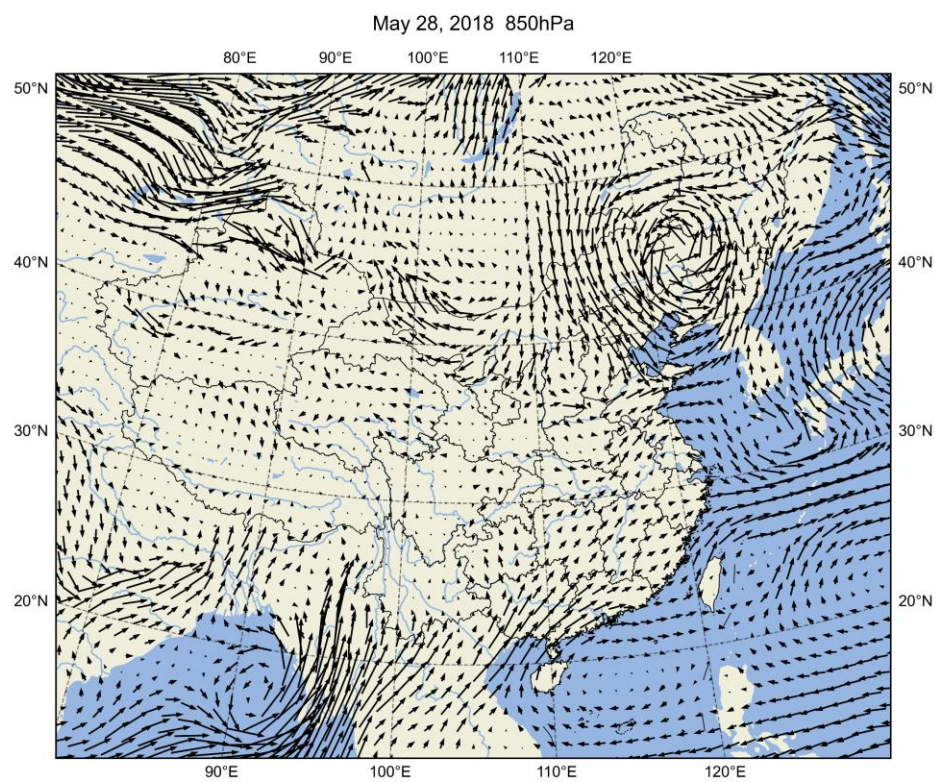
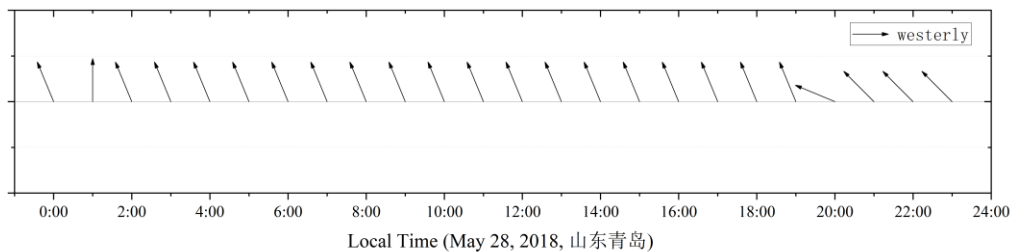

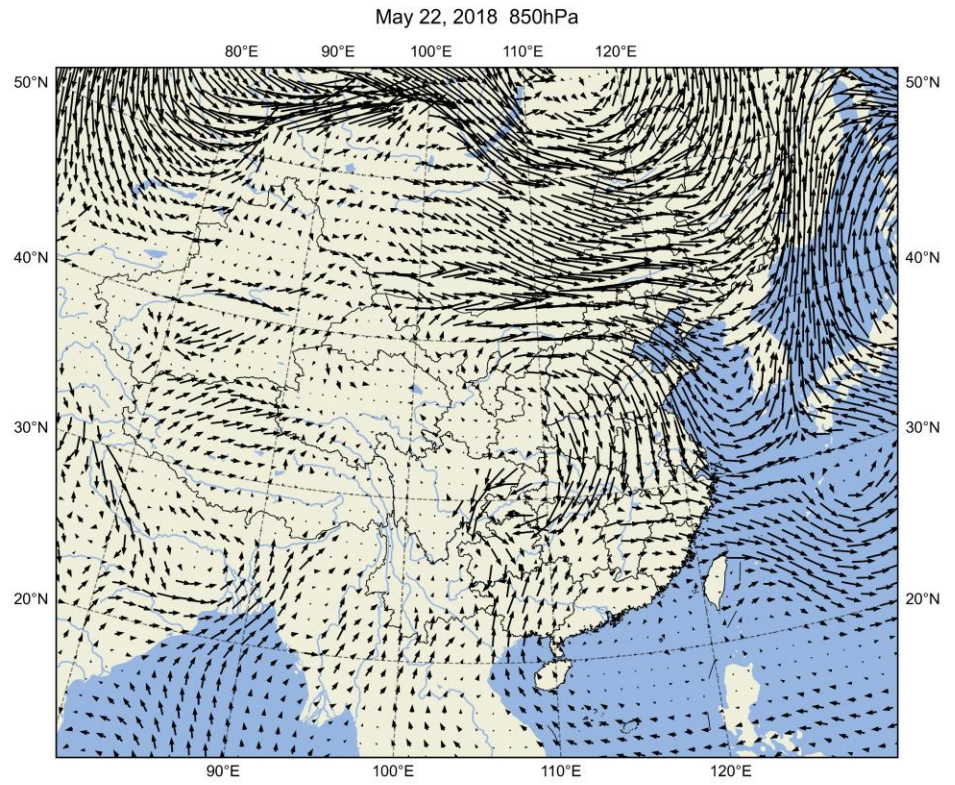
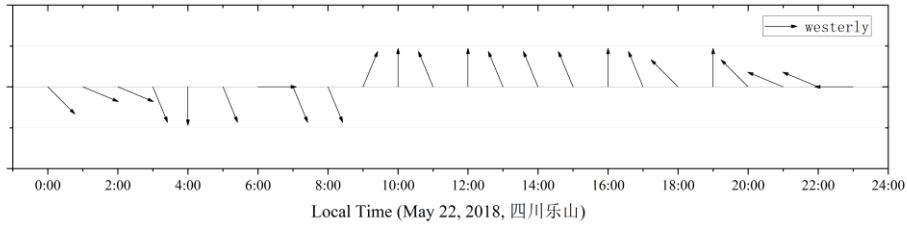

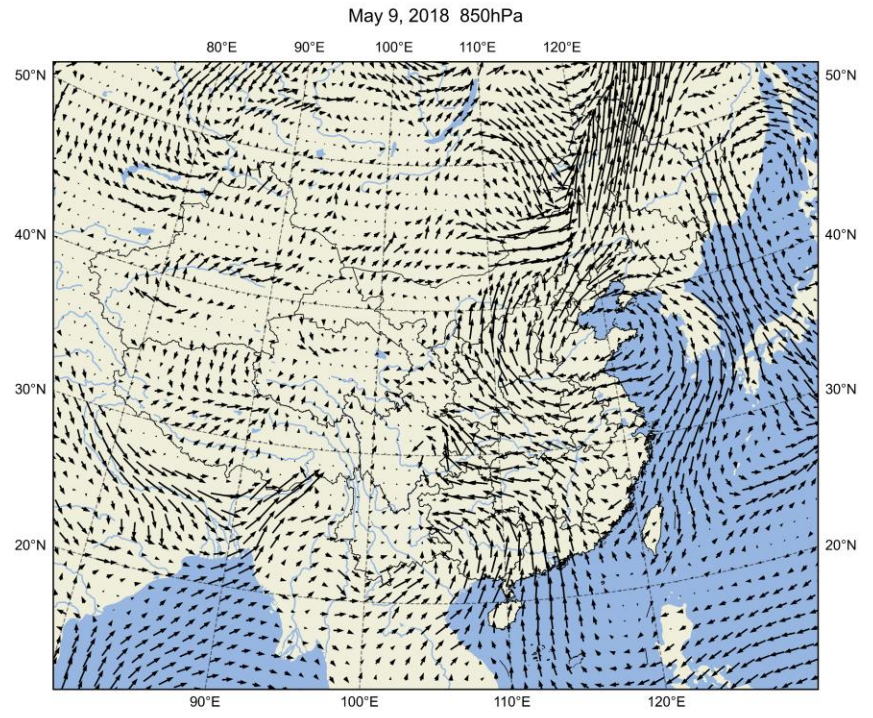
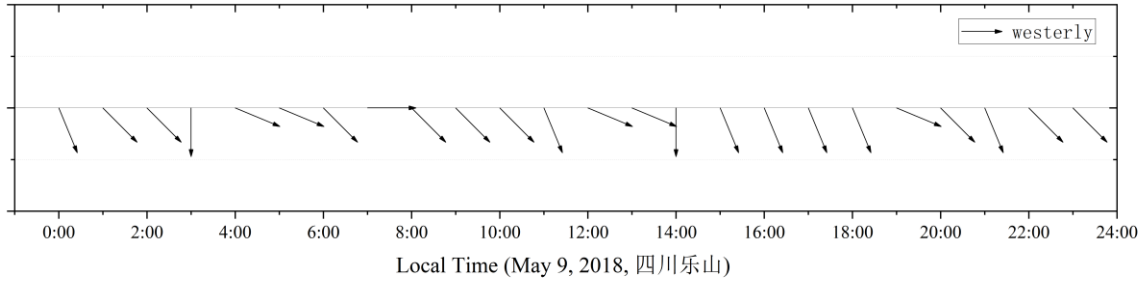

第四章 大气运动和大气环流

4.3 大气环流：风场与洋流（表面风生流）

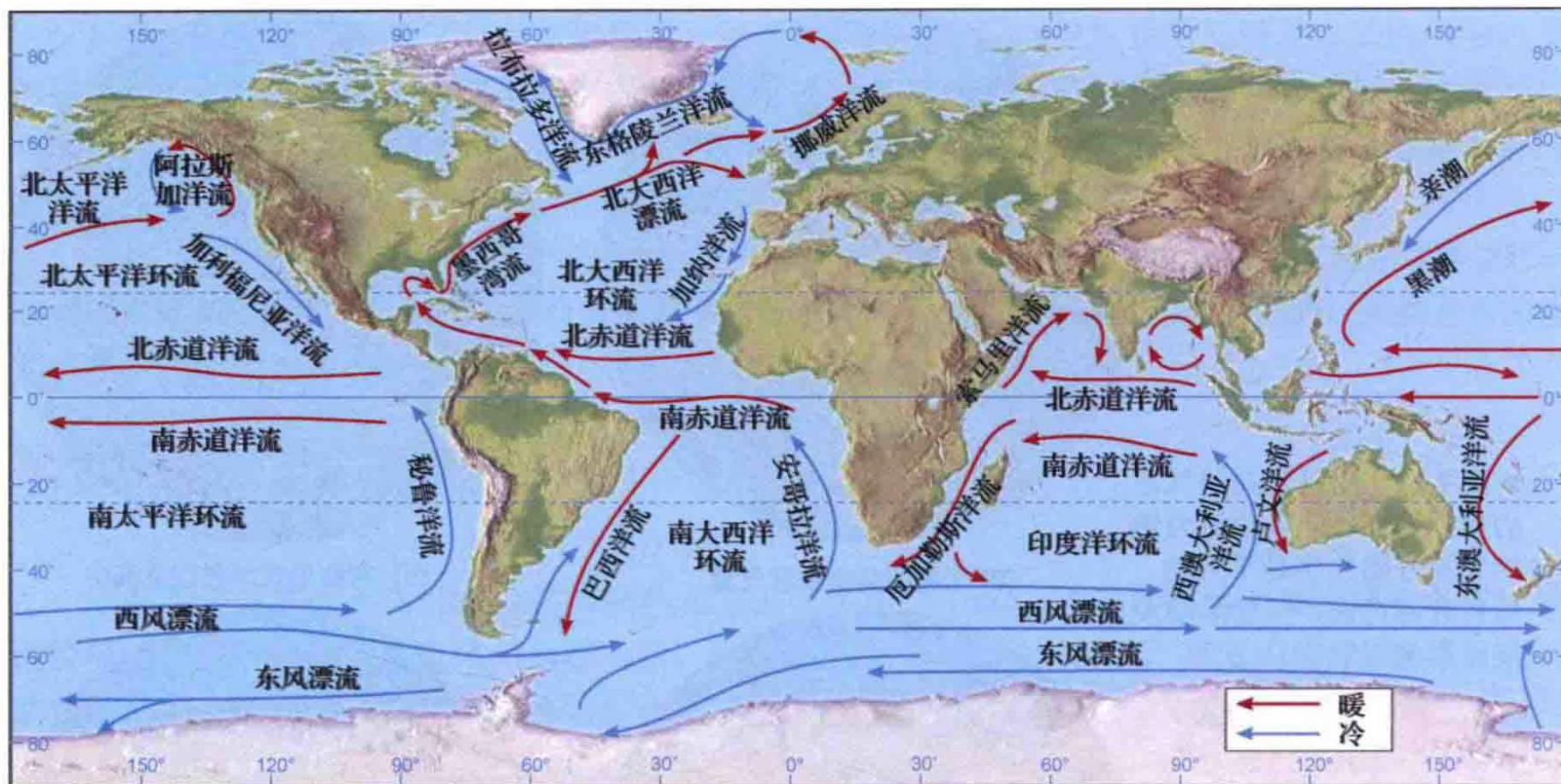

4.3 大气环流：几个概念

经圈环流

水平环流

纬圈环流

4.3 大气环流：几个概念

经圈环流：**三圈环流；夏季逆Hadley环流**

水平环流

纬圈环流

第四章 大气运动和大气环流

4.3 大气环流：几个概念

经圈环流：三圈环流；夏季逆Hadley环流

水平环流：东风，西风急流，季风

纬圈环流

第四章 大气运动和大气环流

4.3 大气环流：几个概念

经圈环流：三圈环流；夏季逆Hadley环流

水平环流：东风，西风急流，季风

纬圈环流：Walker 环流

“三圈环流” 是真实的吗？ Yes & No!

- **Yes:** 解释近地面/对流层低层风分布
- **No:** 不能很好解释对流层高层的气流分布

Temperature gradient 1981-2010: Jan.

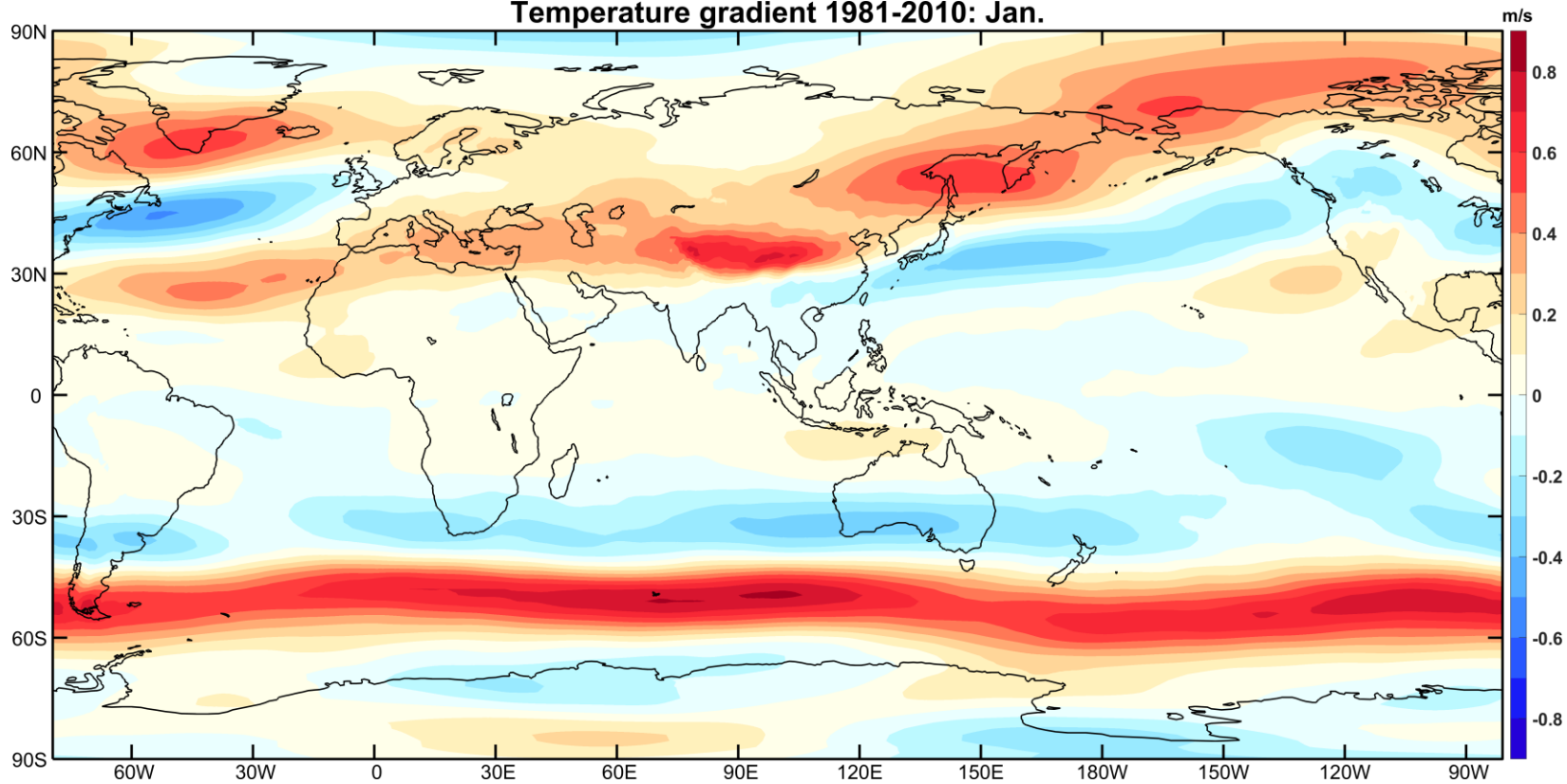

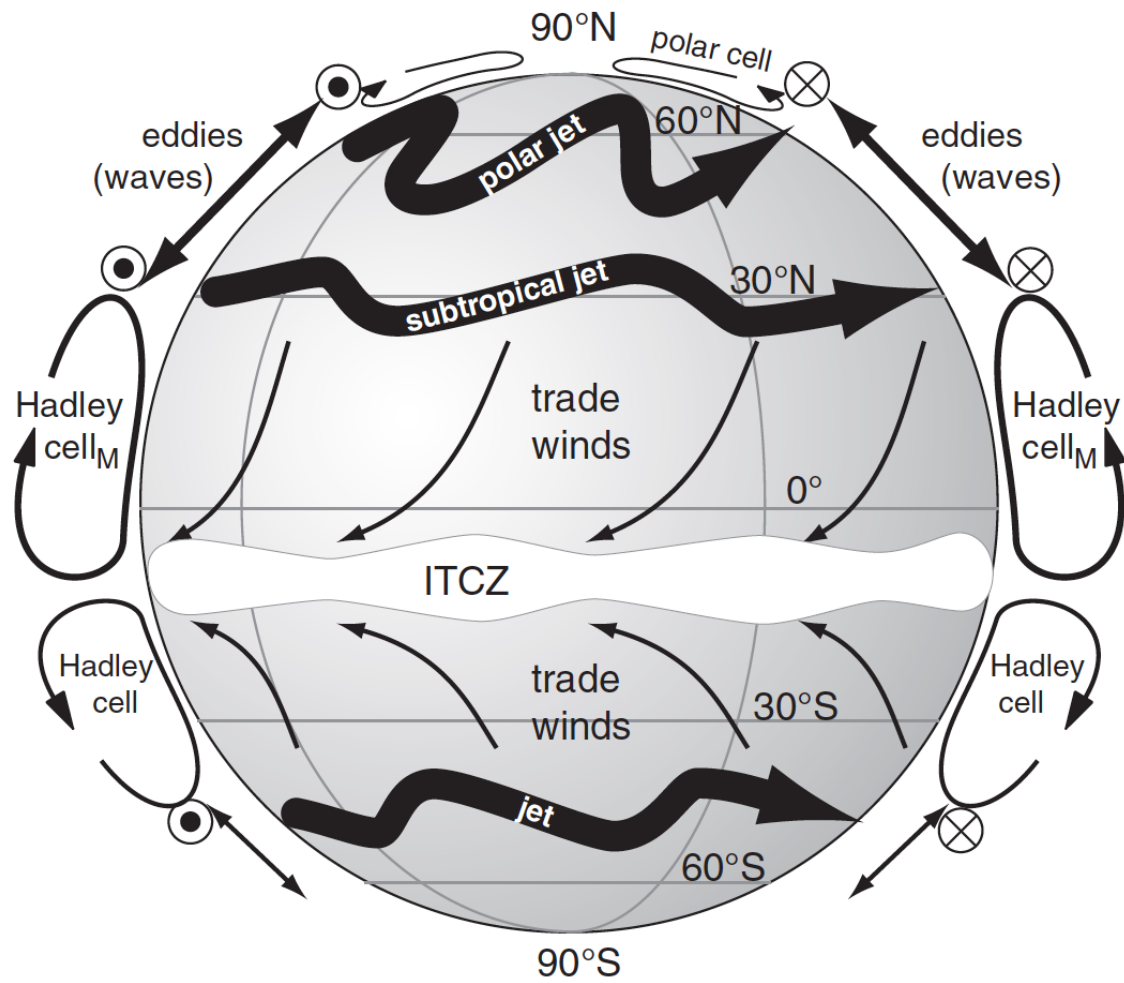

第四章 大气运动和大气环流

4.3 大气环流：几个概念

罗斯贝波 (Rossby) 波：

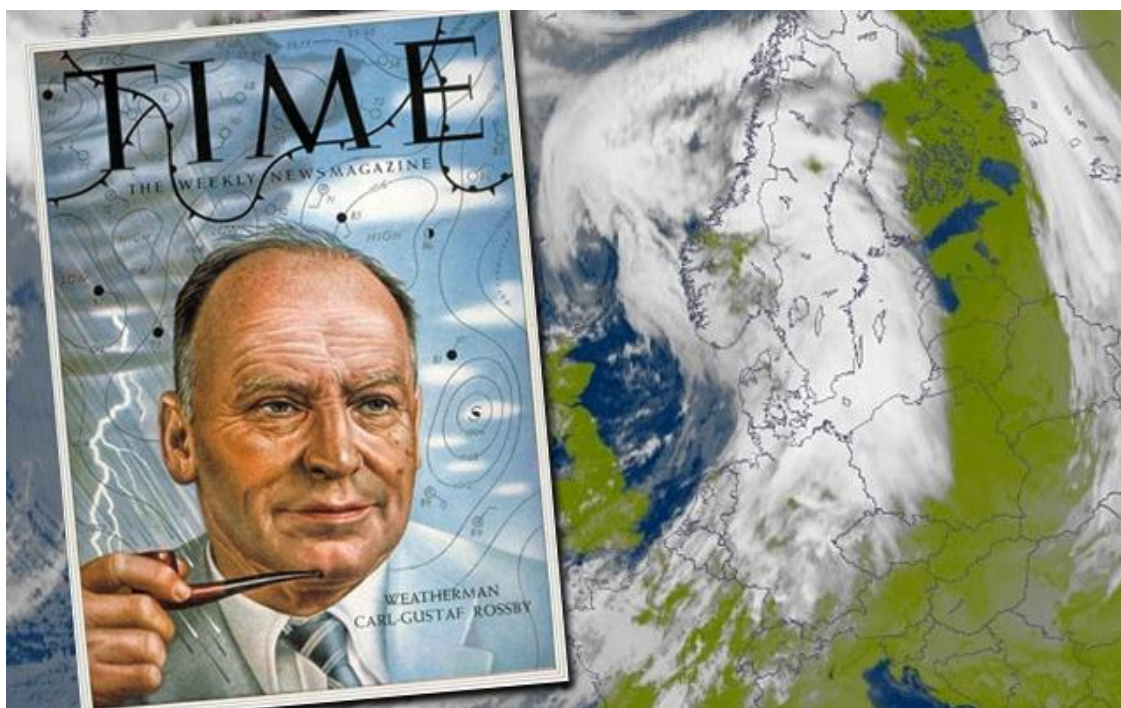

卡尔·古斯塔夫·罗斯贝
Carl-Gustaf Rossby
1898-1957：现代气象学和
海洋学的开拓者。
生于瑞典斯德哥尔摩
美国芝加哥学派创立者
美国第一个气象系创立者

4.3 大气环流：几个概念

罗斯贝波 (Rossby) 波：

大气中的一种非常缓慢的、大尺度的波动。波长3000-6000公里，波数4-7个（相速度，群速度）。罗斯贝波的本质是地转偏向力随纬度变化。

第四章 大气运动和大气环流

4.3 大气环流：几个概念

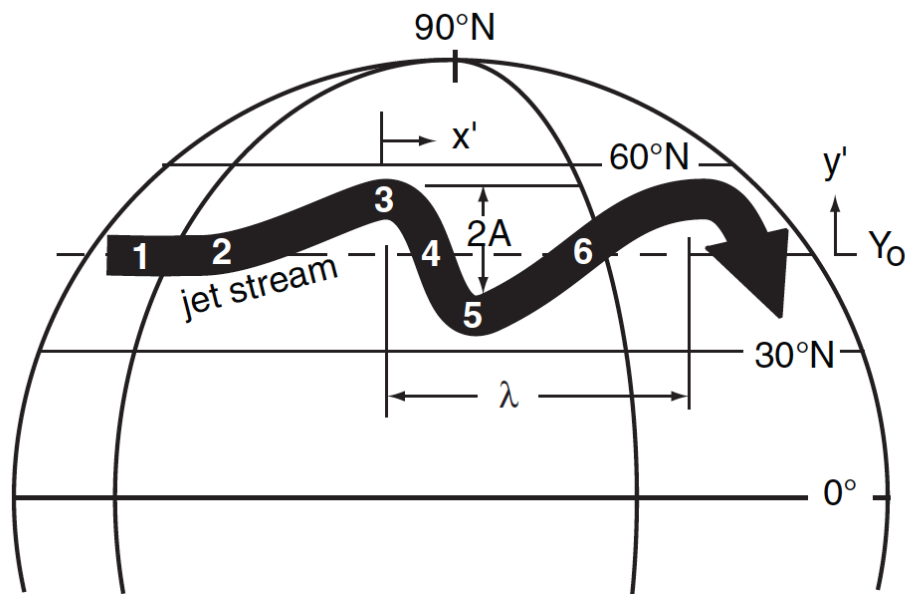

罗斯贝波

沿着急流波导移动

Figure 11.50

Initially zonal flow of the jet stream at point 1, if disturbed at point 2, will develop north-south meanders called Rossby waves. $\lambda = \text{wavelength}$. $A = \text{wave amplitude}$.

4.2 大气环流：小结

重点：

- 三圈环流的形成原理
- 三圈环流对应三维风场和气压场
- 地表在大气环流形成中的作用（海陆分布和高山）
- 局地风的表现形式和形成原因
- 能够看图识别冬夏季全球气压差和风场的差异

Homework 4

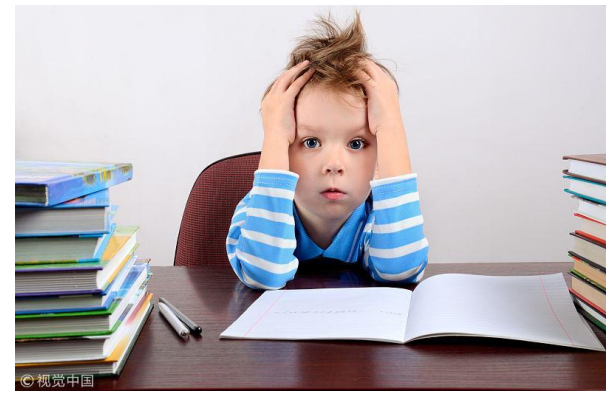

- 绘制三圈环流对应的经圈和地面水平风场和气压场
- 绘制全球主要高低压系统
- 简述青藏高原对大气环流形成中的作用
- 查阅关于Rossby先生的资料，了解大气环流发展的历史